



CST120N03F N-Ch 30V Fast Switching MOSFETs

- ★ Super Low Gate Charge
- ★ 100% EAS Guaranteed
- ★ Green Device Available
- ★ Excellent CdV/dt effect decline
- ★ Advanced high cell density Trench technology

CST120N03F Product Summary



BVDSS	RDS(on)	ID
30V	3.0mΩ	120 A

CST120N03F Description

The CST120N03F is the high cell density trenched N-ch MOSFETs, which provide excellent RDS(on) and gate charge for most of the synchronous buck converter applications. The CST120N03F meet the RoHS and Green Product requirement, 100% EAS guaranteed with full function reliability approved.

CST120N03F PDFN5060-8L Pin Configuration



CST120N03F Absolute Maximum Ratings

Symbol	Parameter	Rating		Units
		10s	Steady State	
V _{DS}	Drain-Source Voltage	30		V
V _{GS}	Gate-Source Voltage	±20		V
I _D @T _C =25°C	Continuous Drain Current, V _{GS} @ 10V ¹	120		A
I _D @T _C =100°C	Continuous Drain Current, V _{GS} @ 10V ¹	75		A
I _{DM}	Pulsed Drain Current ²	384		A
EAS	Single Pulse Avalanche Energy ³	198		mJ
I _{AS}	Avalanche Current	53.8		A
P _D @T _C =25°C	Total Power Dissipation ⁴	62.5		W
P _D @T _A =25°C	Total Power Dissipation ⁴	6	2.42	W
T _{STG}	Storage Temperature Range	-55 to 175		°C
T _J	Operating Junction Temperature Range	-55 to 175		°C

CST120N03F Thermal Data

Symbol	Parameter	Typ.	Max.	Unit
R _{θJA}	Thermal Resistance Junction-Ambient ¹	---	62	°C/W
R _{θJA}	Thermal Resistance Junction-Ambient ¹ (t ≤ 10s)	---	25	°C/W
R _{θJC}	Thermal Resistance Junction-Case ¹	---	2.4	°C/W



CST120N03F N-Ch 30V Fast Switching MOSFETs

CST120N03F Electrical Characteristics ($T_J=25^\circ\text{C}$, unless otherwise noted)

Symbol	Parameter	Test Conditions	Min.	Typ.	Max.	Unit
Static Characteristics						
BV_{DSS}	Drain-Source Breakdown Voltage	$V_{GS}=0V, I_{DS}=250\mu A$	30	-	-	V
I_{DSS}	Zero Gate Voltage Drain Current	$V_{DS}=24V, V_{GS}=0V$	-	-	1	μA
		$T_J=85^\circ\text{C}$	-	-	30	
$V_{GS(th)}$	Gate Threshold Voltage	$V_{DS}=V_{GS}, I_{DS}=250\mu A$	1.4	1.7	2.5	V
I_{GSS}	Gate Leakage Current	$V_{GS}=\pm 20V, V_{DS}=0V$	-	-	± 100	nA
$R_{DS(ON)}^d$	Drain-Source On-state Resistance	$V_{GS}=10V, I_{DS}=20A$	-	3	3.8	m Ω
		$T_J=125^\circ\text{C}$	-	4.4	-	
		$V_{GS}=4.5V, I_{DS}=15A$	-	4.0	5.5	
Gfs	Forward Transconductance	$V_{DS}=5V, I_{DS}=10A$	-	24.6	-	S
Diode Characteristics						
V_{SD}^d	Diode Forward Voltage	$I_{SD}=20A, V_{GS}=0V$	-	0.8	1.1	V
t_{rr}	Reverse Recovery Time	$I_{DS}=20A, di_{SD}/dt=100A/\mu s$	-	35.6	-	ns
t_a	Charge Time		-	19.3	-	
t_b	Discharge Time		-	16.3	-	
Q_{rr}	Reverse Recovery Charge		-	26	-	
Dynamic Characteristics [°]						
R_G	Gate Resistance	$V_{GS}=0V, V_{DS}=0V, F=1\text{MHz}$	-	1	2	Ω
C_{iss}	Input Capacitance	$V_{GS}=0V,$ $V_{DS}=15V,$ Frequency=1.0MHz	-	2485	2971	pF
C_{oss}	Output Capacitance		-	850	-	
C_{riss}	Reverse Transfer Capacitance		-	85	-	
$t_{d(ON)}$	Turn-on Delay Time	$V_{DD}=15V, R_L=15\Omega,$ $I_{DS}=1A, V_{GEN}=10V,$ $R_G=6\Omega$	-	12.4	23	ns
t_r	Turn-on Rise Time		-	9.5	18	
$t_{d(OFF)}$	Turn-off Delay Time		-	27.2	49	
t_f	Turn-off Fall Time		-	35.2	64	
Gate Charge Characteristics [°]						
Q_g	Total Gate Charge	$V_{DS}=15V, V_{GS}=10V,$ $I_{DS}=20A$	-	20.6	28.8	nC
Q_g	Total Gate Charge	$V_{DS}=15V, V_{GS}=4.5V,$ $I_{DS}=20A$	-	9.8	-	
Q_{gth}	Threshold Gate Charge		-	1.8	-	
Q_{gs}	Gate-Source Charge		-	3.8	-	
Q_{gd}	Gate-Drain Charge		-	3.7	-	

Note d : Pulse test ; pulse width $\leq 300\mu s$, duty cycle $\leq 2\%$.

Note e : Guaranteed by design, not subject to production testing.



CST120N03F Typical Operating Characteristics

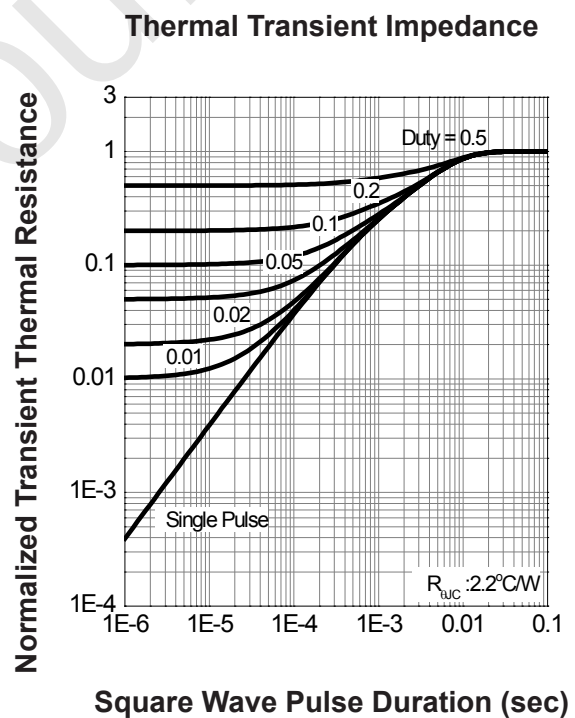
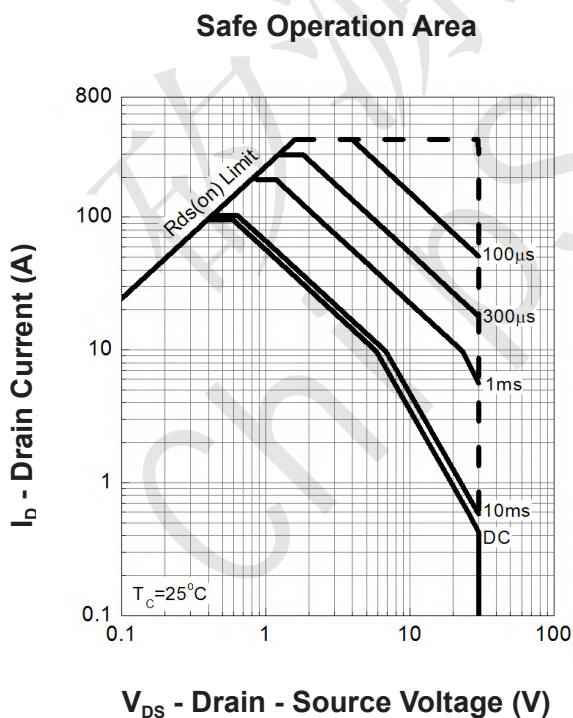
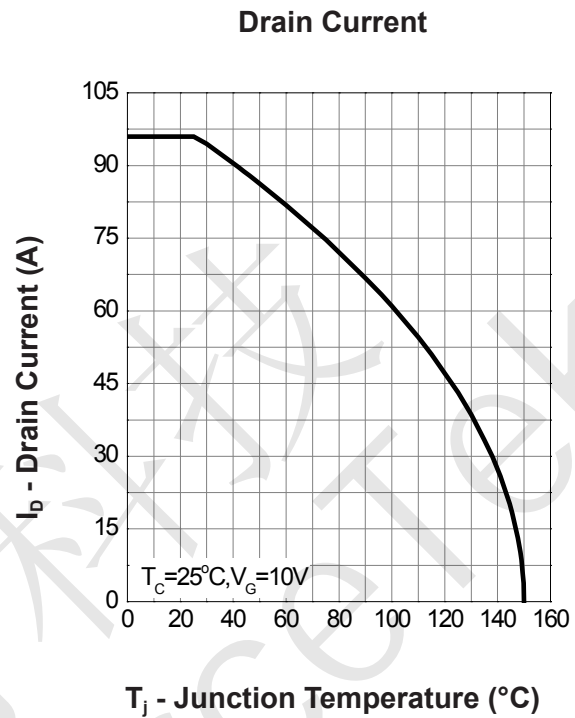
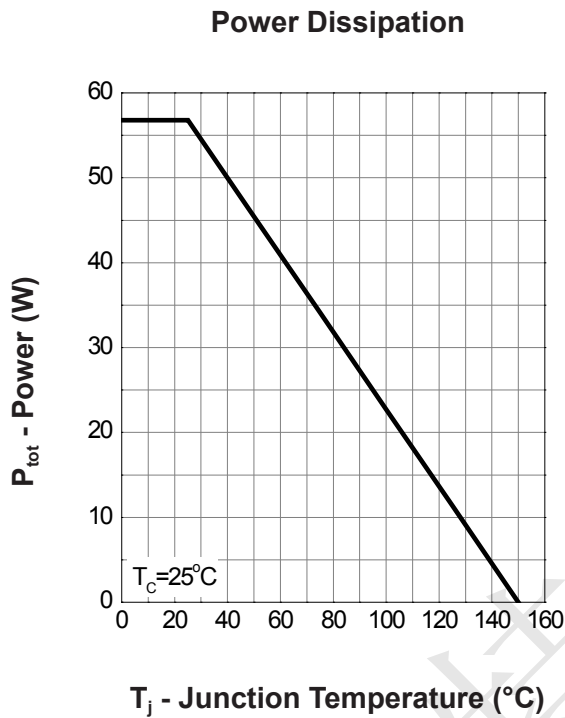



CST120N03F Typical Operating Characteristics(Cont.)

Safe Operation Area

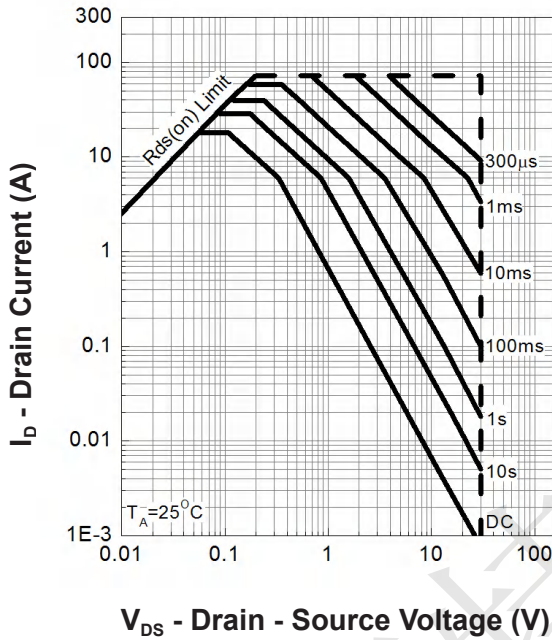

Thermal Transient Impedance

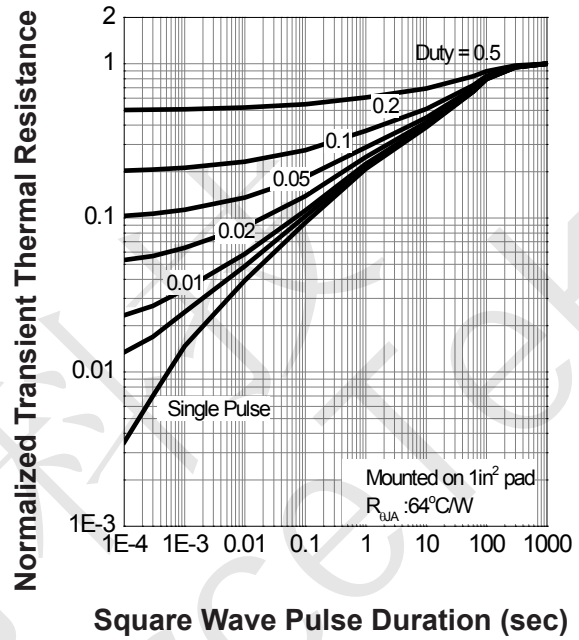

Output Characteristics

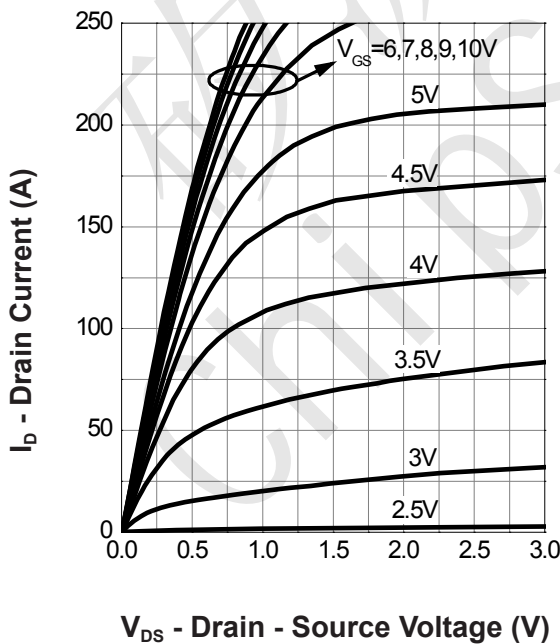

Drain-Source On Resistance

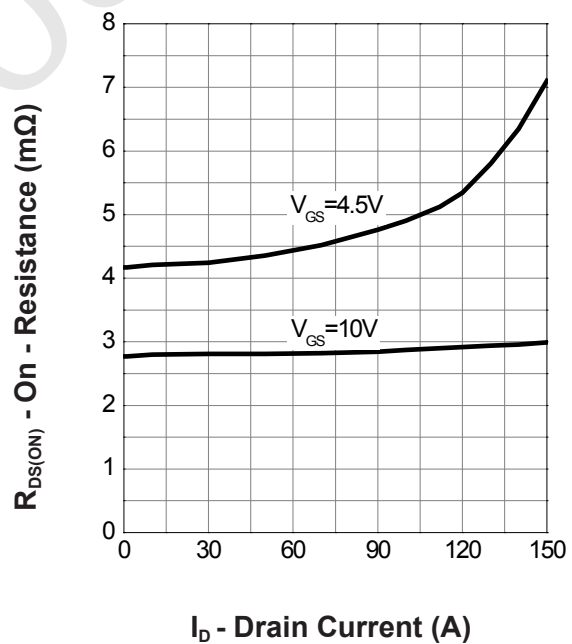



CST120N03F Typical Operating Characteristics(Cont.)

Gate-Source On Resistance

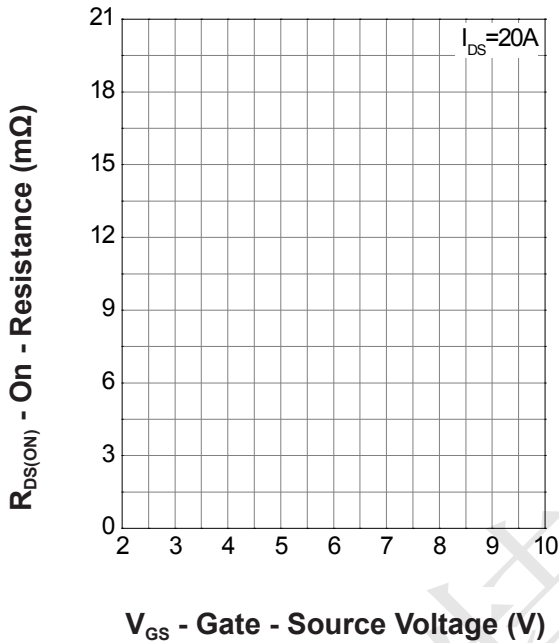

Gate Threshold Voltage

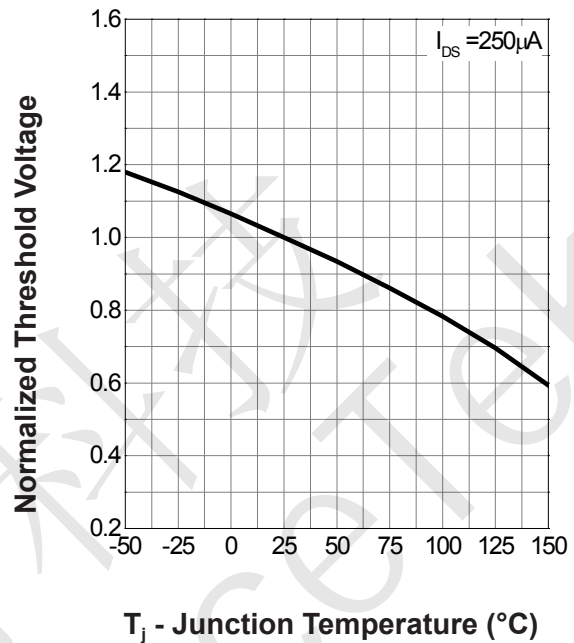

Drain-Source On Resistance

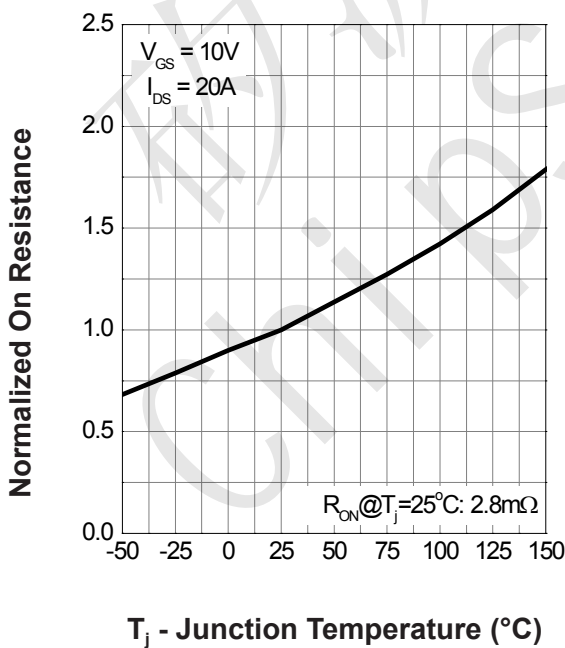

Source-Drain Diode Forward

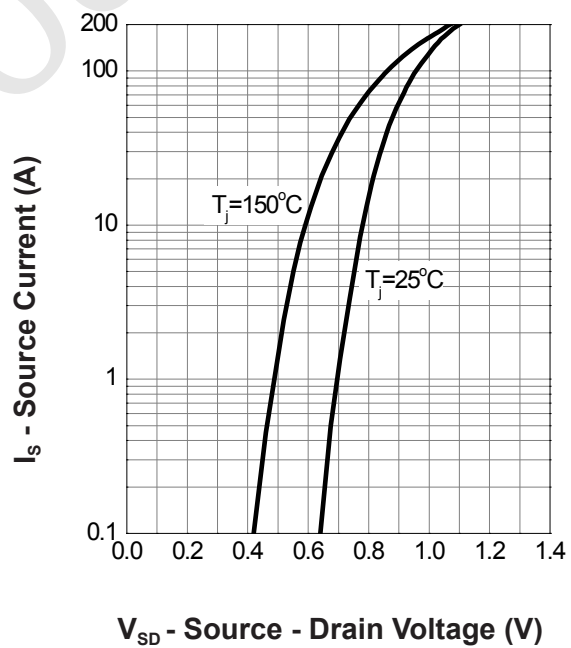



CST120N03F Typical Operating Characteristics(Cont.)

Capacitance

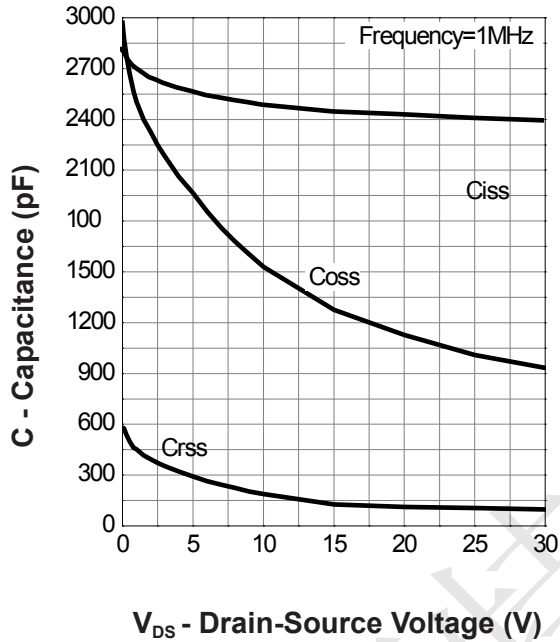

Gate Charge

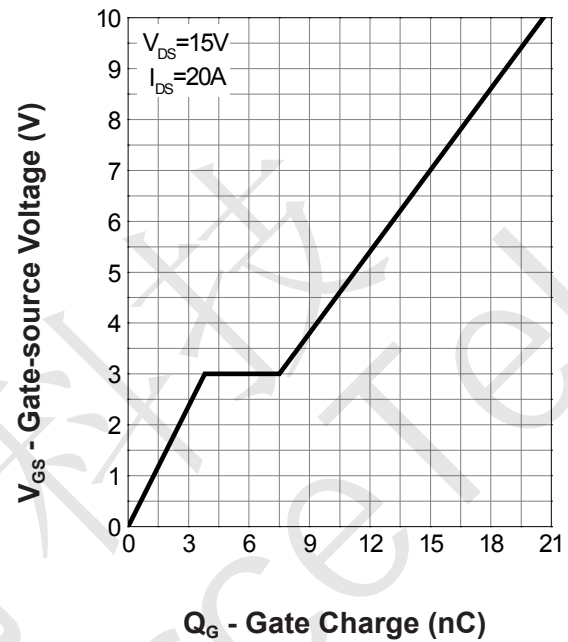



CST120N03F Package Mechanical Data-PDFN5060-8L-Single

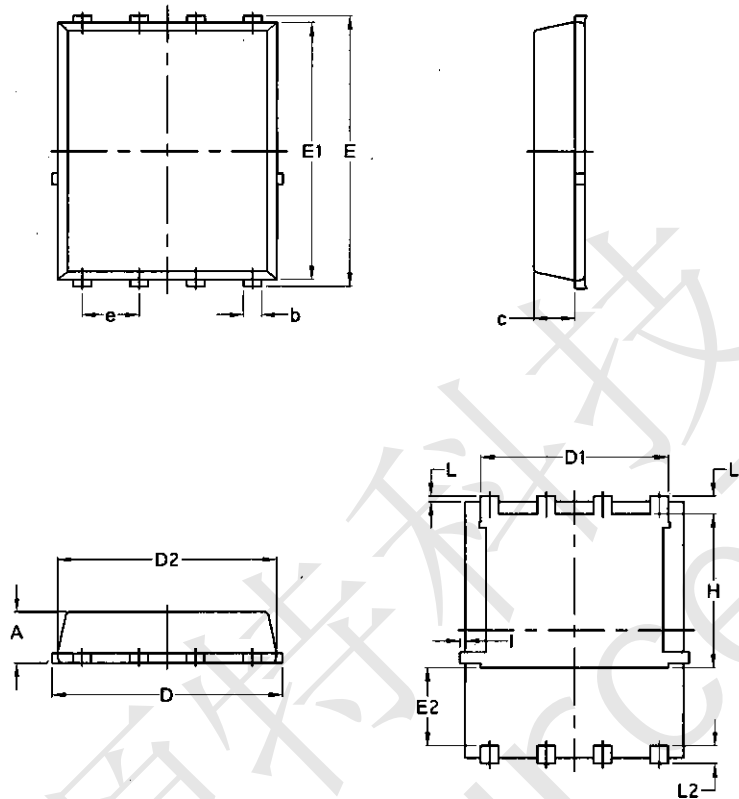

Symbol	Common			
	mm		Inch	
	Min	Max	Min	Max
A	1.03	1.17	0.0406	0.0461
b	0.34	0.48	0.0134	0.0189
c	0.824	0.0970	0.0324	0.082
D	4.80	5.40	0.1890	0.2126
D1	4.11	4.31	0.1618	0.1697
D2	4.80	5.00	0.1890	0.1969
E	5.95	6.15	0.2343	0.2421
E1	5.65	5.85	0.2224	0.2303
E2	1.60	/	0.0630	/
e	1.27 BSC		0.05 BSC	
L	0.05	0.25	0.0020	0.0098
L1	0.38	0.50	0.0150	0.0197
L2	0.38	0.50	0.0150	0.0197
H	3.30	3.50	0.1299	0.1378
I	/	0.18	/	0.0070