



## RX2212 One Cell Li-ion and Li-poly Battery Protection IC

### RX2212 Features

- Protection of Battery Cell Reverse Connection without External load
- Over-temperature Protection
- Overcharge Current Protection
- Two-step Overcurrent Detection: Over Discharge Current Load Short Circuiting
- Charger Detection Function
- 0V Battery Charging Function
- RoHS Compliant and Lead (Pb) Free
- 8mΩ Low  $R_{SS(ON)}$  Internal Power MOSFET
- Delay Times are generated inside
- High-accuracy Voltage Detection
- Low Current Consumption  
Operation Mode: 0.7μA typ.  
Power-down Mode: 0.5μA typ.
- Only One External Capacitor Required
- Available in ESOP8 Package
- -40°C to +85°C Temperature Range

### RX2212 Applications

- One-Cell Li-ion Battery Pack
- Power Bank
- One-Cell Li-poly Battery Pack
- IOT Sensor/Electronic Toys

### RX2212 General Description

The RX2212 is a high integration solution for lithium-ion/polymer battery protection. RX2212 contains internal power MOSFET, high-accuracy voltage detection circuits and delay circuits. RX2212 has all the protection functions required in the battery application including overcharging, over discharging, overcurrent and load short circuiting protection etc. The accurate overcharging detection voltage ensures safe and full utilization charging. The low standby current drains little current from the cell while in storage. The device is not only targeted for digital cellular phones, but also for any other Li-Ion and Li-Poly battery-powered information appliances requiring long-term battery life.

The RX2212 requires a minimal number of readily available, external components and is available in a space saving ESOP8 package.

### RX2212 Typical Application Circuit

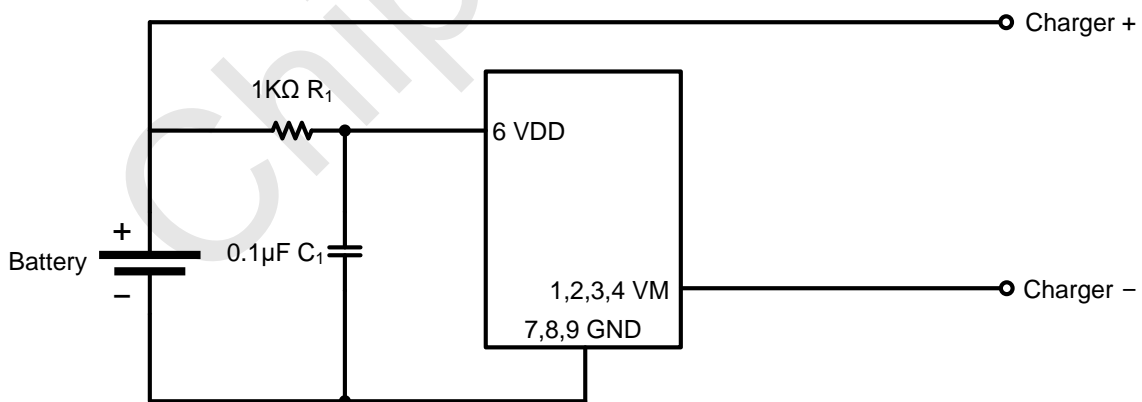

Figure 1. Typical Application Circuit



## R<sub>Y</sub>2212 One Cell Li-ion and Li-poly Battery Protection IC

### R<sub>Y</sub>2212 Pin Description

#### Pin Configuration

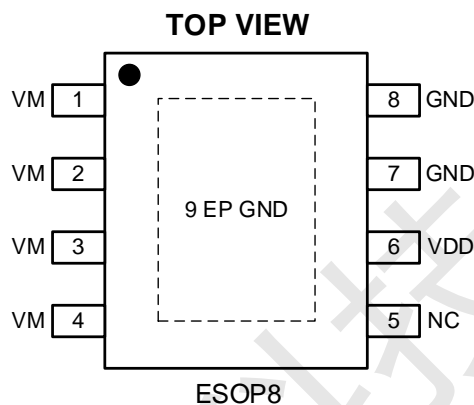

Figure 2. Pin Configuration

Top Marking: MVYLL (device code: MV, Y=year code, LL= lot number code)

#### Pin Description

Pin	Name	Function
1	VM	The negative terminal of the battery pack. The internal FET switch connects this terminal to GND
2	VM	The negative terminal of the battery pack. The internal FET switch connects this terminal to GND
3	VM	The negative terminal of the battery pack. The internal FET switch connects this terminal to GND
4	VM	The negative terminal of the battery pack. The internal FET switch connects this terminal to GND
5	NC	No connect
6	VDD	Power Supply Pin
7	GND	Ground Pin
8	GND	Ground Pin
9	EPAD	Connected to Ground

#### R<sub>Y</sub>2212 Order Information <sup>(1)</sup>

Marking	Part No.	Model	Description	Package	T/R Qty
MVYLL	70702042	RY2212	RY2212 One Cell Li-ion and Li-poly Battery Protection IC, 16A, ESOP8	ESOP8	3000 PCS

Note (1): All parts are Pb-Free and adhere to the RoHS directive.



## R Y2212 One Cell Li-ion and Li-poly Battery Protection IC

### R Y2212 Specifications

#### Absolute Maximum Ratings <sup>(1)</sup> <sup>(2)</sup>

Item	Min	Max	Unit
VDD Input Voltage	-0.3	6	V
VM Input Voltage	-6	10	V
Power dissipation	Internally Limited		
Operating Junction Temperature, T <sub>J</sub>	-40	150	°C
Storage Temperature, T <sub>stg</sub>	-55	150	°C
Operating Temperature Range	-40	85	°C
Lead Temperature (Soldering, 10sec.)		260	°C

Note (1): Exceeding these ratings may damage the device.

Note (2): The device is not guaranteed to function outside of its operating conditions.

#### ESD Ratings

Item	Description	Value	Unit
V <sub>(ESD-HBM)</sub>	Human Body Model (HBM) ANSI/ESDA/JEDEC JS-001-2014 Classification, Class: 2	±2000	V
V <sub>(ESD-CDM)</sub>	Charged Device Model (CDM) ANSI/ESDA/JEDEC JS-002-2014 Classification, Class: C0b	±200	V
I <sub>LATCH-UP</sub>	JEDEC STANDARD NO.78E APRIL 2016 Temperature Classification, Class: I	±150	mA

#### Recommended Operating Conditions

Item	Min	Max	Unit
Operating junction temperature <sup>(1)</sup>	-40	125	°C
Operating temperature range	-40	85	°C

Note (1): All limits specified at room temperature (TA = 25°C) unless otherwise specified. All room temperature limits are 100% production tested. All limits at temperature extremes are ensured through correlation using standard Statistical Quality Control (SQC) methods. All limits are used to calculate Average Outgoing Quality Level (AOQL).

#### Thermal Information

Item	Description	Value	Unit
R <sub>θJA</sub>	Junction-to-ambient thermal resistance <sup>(1)(2)</sup>	48.7	°C/W
R <sub>θJC(top)</sub>	Junction-to-case (top) thermal resistance	52.4	°C/W
R <sub>θJB</sub>	Junction-to-board thermal resistance	25.5	°C/W
ψ <sub>JT</sub>	Junction-to-top characterization parameter	8.4	°C/W
ψ <sub>JB</sub>	Junction-to-board characterization parameter	25.2	°C/W
R <sub>θJC</sub>	Junction-to-case (Bottom) thermal resistance	6.5	°C/W

Note (1): The package thermal impedance is calculated in accordance to JESD 51-7.



## Ry2212 One Cell Li-ion and Li-poly Battery Protection IC

Note (2): Thermal Resistances were simulated on a 4-layer, JEDEC board.

### Ry2212 Electrical Characteristics <sup>(1)</sup>

T<sub>A</sub>=25°C, unless otherwise specified.

Parameter	Symbol	Test Conditions	Min	Typ.	Max	Unit
<b>Detection Voltage</b>						
Overcharge Detection Voltage	V <sub>CU</sub>		4.25	4.3	4.35	V
Overcharge Release Voltage	V <sub>CL</sub>		4.05	4.1	4.15	V
Overdischarge Detection Voltage	V <sub>DL</sub>		2.3	2.4	2.5	V
Overdischarge Release Voltage	V <sub>DR</sub>		2.9	3.0	3.1	V
<b>Detection Current</b>						
Overcharge Current Detection	*I <sub>CU</sub>	V <sub>DD</sub> =3.6V	4.0	6.0	8.0	A
Overdischarge Current I Detection	*I <sub>IOV1</sub>	V <sub>DD</sub> =3.6V		16		A
Load Short-Circuiting Detection	*I <sub>SHORT</sub>	V <sub>DD</sub> =3.6V		40		A
<b>Current Consumption</b>						
Current Consumption in Operation	I <sub>OPe</sub>	V <sub>DD</sub> =3.6V V <sub>M</sub> =0V	0.1	0.7	2	μA
Current Consumption in power Down	I <sub>PDN</sub>	V <sub>DD</sub> =2.0V V <sub>M</sub> floating	0.1	0.5	1	μA
<b>VM Internal Resistance</b>						
Resistance between VM and V <sub>DD</sub>	*R <sub>VMD</sub>	V <sub>DD</sub> =3.6V V <sub>M</sub> =1.0V	100	300	500	kΩ
Resistance between VM and GND	*R <sub>VMS</sub>	V <sub>DD</sub> =2.0V V <sub>M</sub> =1.0V	10	20	40	kΩ
<b>FET on Resistance</b>						
Equivalent FET on Resistance	*R <sub>SS(ON)</sub>	V <sub>DD</sub> =3.6V I <sub>VM</sub> =1.0A		8		mΩ
<b>Over Temperature Protection</b>						
Over Temperature Protection	*T <sub>SHD+</sub>			130		°C
Over Temperature Recovery Degree	*T <sub>SHD-</sub>			100		°C
<b>Detection Delay Time</b>						
Overcharge Voltage Detection Delay Time	t <sub>CU</sub>		60	80	120	mS
Overdischarge Voltage Detection Delay Time	t <sub>DL</sub>		30	60	80	mS
Overcharge Current Detection Delay Time	*t <sub>CU</sub>	V <sub>DD</sub> =3.6V	5	10	20	mS
Overdischarge Current Detection Delay Time	*t <sub>IOV</sub>	V <sub>DD</sub> =3.6V	5	10	20	mS
Load Short-Circuiting Detection Delay Time	*t <sub>SHORT</sub>	V <sub>DD</sub> =3.6V	100	160	320	μS

Note 3: \*The parameter is guaranteed by design.



### Ry2212 One Cell Li-ion and Li-poly Battery Protection IC

#### Ry2212 Typical Performance Characteristics (1) (2)

Note (1): Performance waveforms are tested on the evaluation board.

Note (2):  $V_{IN}=4.5V$ ,  $R_1=1K\Omega$ ,  $C_1=0.1\mu F$ ,  $T_A = +25^\circ C$ , unless otherwise noted.

#### Supply Current vs. VIN

$V_{DD}=0-6V$

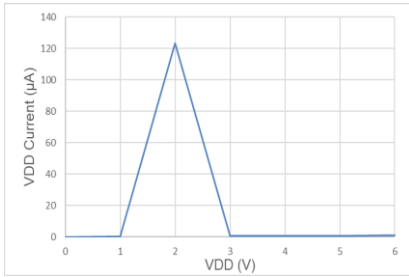

#### Supply Current vs. VM

$V_{DD}=3.6V$

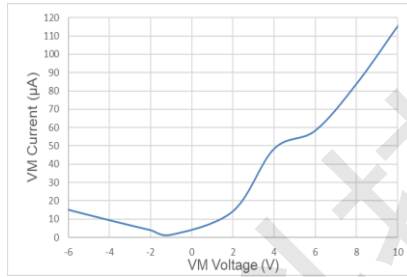

#### Power On

$R_{BAT}=5\ \Omega$

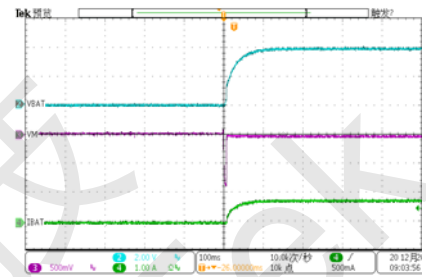

#### Power Off

$R_{BAT}=5\ \Omega$

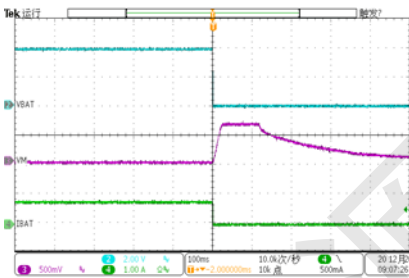

#### Battery Charging On

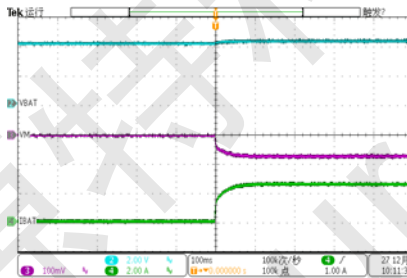

#### Battery Charging Off

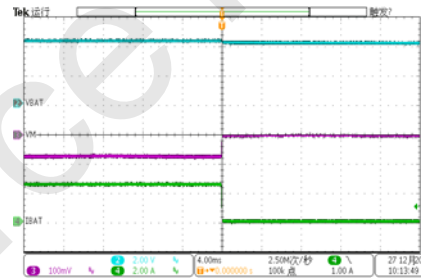

#### Battery Charging, OCP

$I_{BAT}\geq 7A$

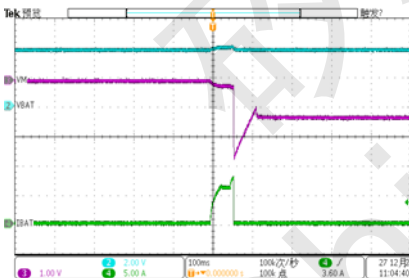

#### Battery Charging OVP

$V_{BAT}\geq 4.3V$

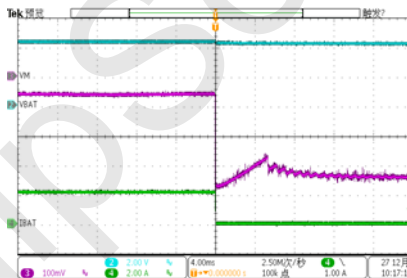

#### Overdischarge Protection UVP

Reduce  $V_{OUT}$  to UVP Point

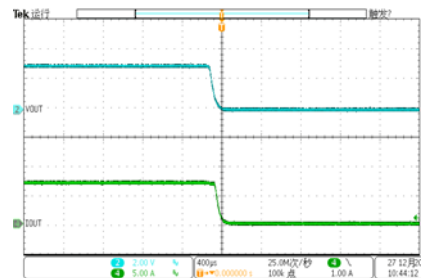

#### Overdischarge Protection OCP +

Increase  $I_{OUT}$  to OCP Point

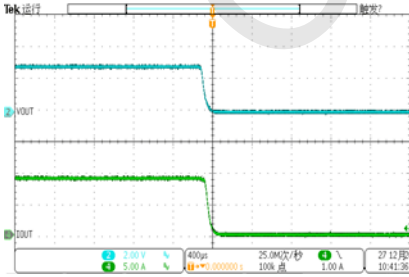

#### SCP Entry

Short Charger+ to Charger-

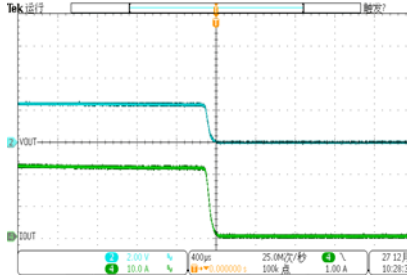

#### OTP

$I_{BAT}=2A$ , Increase  $T_{SHD+}$  to  $130^\circ C$

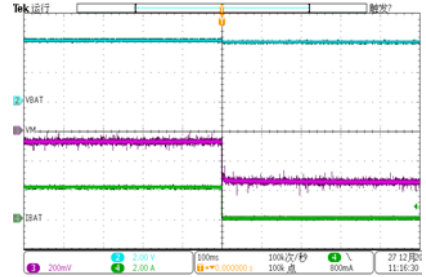



## RX2212 One Cell Li-ion and Li-poly Battery Protection IC

### RX2212 Functional Block Diagram

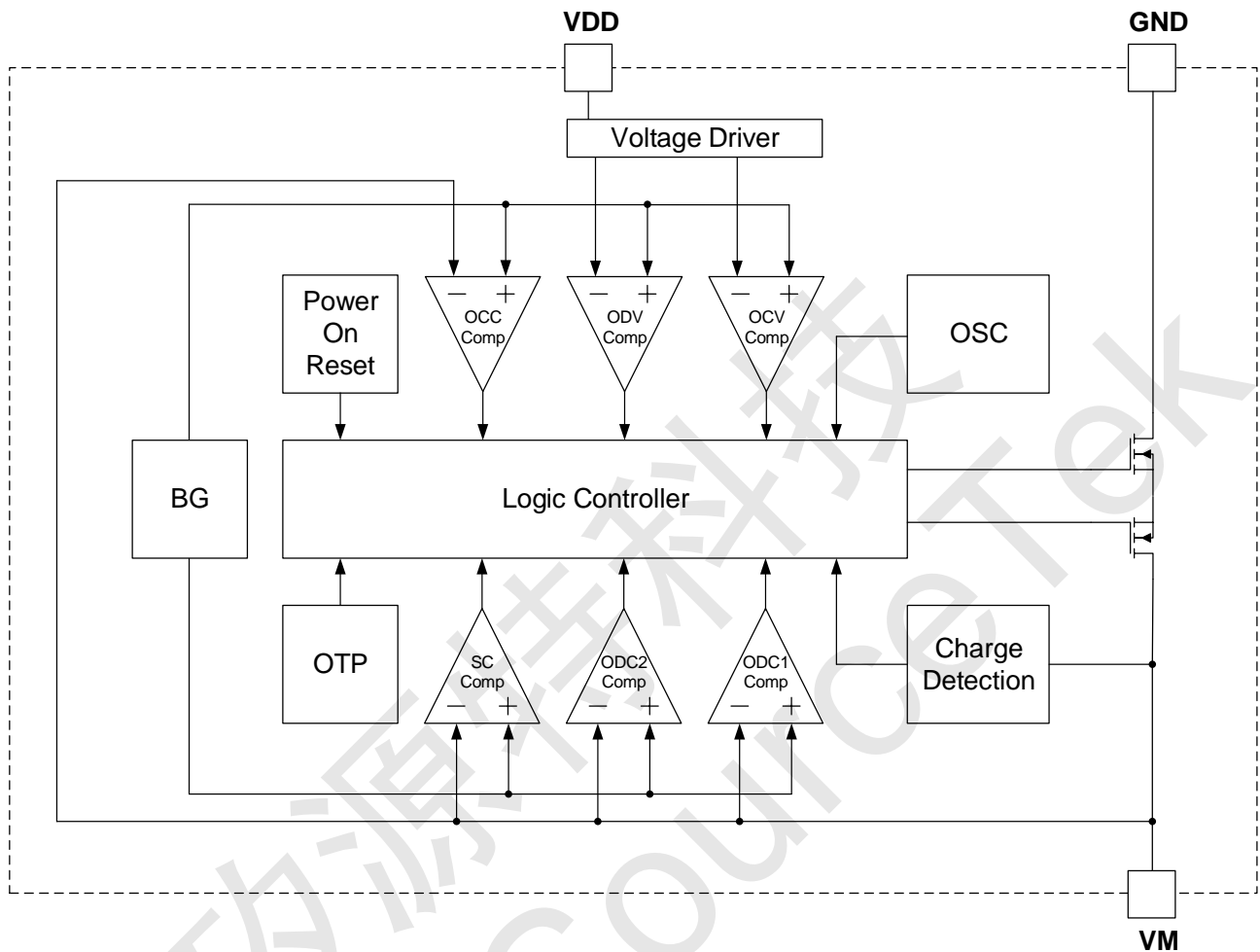

Figure 3. Functional Block Diagram

### RX2212 Functions Description

The RX2212 monitors the voltage and current of a battery and protects it from being damaged due to overcharge voltage, over discharge voltage, over discharge current, and short circuit conditions by disconnecting the battery from the load or charger. These functions are required in order to operate the battery cell within specified limits.

The device requires only one external capacitor. The MOSFET is integrated and its  $R_{SS(ON)}$  is as low as  $5.5m\Omega$  typical.

#### Normal Operating Mode

If no exception condition is detected, charging and discharging can be carried out freely. This condition is called the normal operating mode.

#### Overcharge Status

When the battery voltage becomes higher than the overcharge detection voltage ( $V_{CU}$ ) during charging under normal condition and the state continues for the overcharge detection delay time ( $t_{CU}$ ) or longer, the RX2212 turns the charging control FET off to stop charging. This condition is called the overcharge status. The overcharge condition is released in the following two cases:



## **RY2212 One Cell Li-ion and Li-poly Battery Protection IC**

1. When the battery voltage drops below the overcharge release voltage ( $V_{CL}$ ), the RY2212 turns the charging control FET on and returns to the normal condition.
2. When a load is connected and discharging starts, the RY2212 turns the charging control FET on and returns to the normal condition. The release mechanism is as follows: the discharging current flows through an internal parasitic diode of the charging FET immediately after a load is connected and discharging starts, and the VM pin voltage increases about 0.7V (forward voltage of the diode) from the GND pin voltage momentarily. The RY2212 detects this voltage and releases the overcharge condition. Consequently, in the case that the battery voltage is equal to or lower than the overcharge detection voltage ( $V_{CU}$ ), the RY2212 returns to the normal condition immediately, but in the case the battery voltage is higher than the overcharge detection voltage ( $V_{CU}$ ), the chip does not return to the normal condition until the battery voltage drops below the overcharge detection voltage ( $V_{CU}$ ) even if the load is connected. In addition, if the VM pin voltage is equal to or lower than the overcurrent 1 detection voltage when a load is connected and discharging starts, the chip does not return to the normal condition.

**Remark** If the battery is charged to a voltage higher than the overcharge detection voltage ( $V_{CU}$ ), and even if a large load causing an overcurrent is connected, the battery voltage will not fall below the overcharge detection voltage ( $V_{CU}$ ), and the overcurrent or load short detection will be detected in the battery. It does not work until the voltage is lower than the overcharge detection voltage ( $V_{CU}$ ). However, since the internal impedance of the actual battery has several tens of  $m\Omega$ , and the battery voltage immediately drops after the connection of the heavy load causing the overcurrent, the overcurrent operates. The load short-circuit detection works properly regardless of the battery voltage.

### **Over-discharge Status**

When the battery voltage drops below the over-discharge detection voltage ( $V_{DL}$ ) during discharging under normal condition and it continues for the over-discharge detection delay time ( $t_{DL}$ ) or longer, the RY2212 turns the discharging control FET off and stops discharging. This condition is called over-discharge status. After the discharging control FET is turned off, the VM pin is pulled up by the  $R_{VMD}$  resistor between VM and VDD in RY2212. Meanwhile when VM is bigger than 1.5V (typ.) (the load short-circuiting detection voltage), the current of the chip is reduced to the power-down current ( $I_{PDN}$ ). This condition is called power-down condition. The VM and VDD pins are shorted by the  $R_{VMD}$  resistor in the IC under the over-discharge and power-down conditions. The power-down condition is released when a charger is connected and the potential difference between VM and VDD becomes 1.3V (typ.) or higher (load short-circuiting detection voltage). At this time, the FET is still off. When the battery voltage becomes the over-discharge detection voltage ( $V_{DL}$ ) or higher (see note), the RY2212 turns the FET on and changes to the normal condition from the over-discharge condition.

**Remark** If the VM pin voltage is not less than the charger detection voltage ( $V_{CHA}$ ) and the battery voltage reaches the over-discharge release voltage ( $V_{DR}$ ) or higher, the over-discharge condition is released when the battery under over-discharge condition is connected to the charger (The discharge control FET is turned on).

### **Overcurrent Status**

When the discharging current becomes equal to or higher than a specified value (the VM pin voltage is equal to or higher than the overcurrent detection voltage) during discharging under normal condition and the state continues for the overcurrent detection delay time or longer, the RY2212 turns off the discharging control FET to stop discharging. This condition is called overcurrent status. (The overcurrent includes overcurrent, or load shortcircuiting.) The VM and GND pins are shorted internally by the  $R_{VMS}$  resistor under the overcurrent condition. When a load is connected, the VM pin voltage equals the VDD voltage due to the load. The overcurrent condition



## RY2212 One Cell Li-ion and Li-poly Battery Protection IC

returns to the normal condition when the load is released and the impedance between the B+ and B- pins becomes higher than the automatic recoverable impedance. When the load is removed, the VM pin goes back to the GND potential since the VM pin is shorted the GND pin with the  $R_{VMs}$  resistor. Detecting that the VM pin potential is lower than the overcurrent detection voltage ( $V_{IOV}$ ), the IC returns to the normal condition.

### Abnormal Charge Current Detection

the VM pin voltage drops below the charger detection voltage ( $V_{CHA}$ ) during charging under the normal condition and it continues for the overcharge detection delay time ( $t_{CU}$ ) or longer, the RY2212 turns the charging control FET off and stops charging. This action is called abnormal charge current detection. Abnormal charge current detection works when the discharging control FET is on and the VM pin voltage drops below the charger detection voltage ( $V_{CHA}$ ). When an abnormal charge current flows into a battery in the overdischarge condition, the RY2212 consequently turns the charging control FET off and stops charging after the battery voltage becomes the overdischarge detection voltage and the overcharge detection delay time ( $t_{CU}$ ) elapses.

Abnormal charge current detection is released when the voltage difference between VM pin and GND pin becomes lower than the charger detection voltage ( $V_{CHA}$ ) by separating the charger. Since the 0V battery charging function has higher priority than the abnormal charge current detection function, abnormal charge current may not be detected by the product with the 0V battery charging function while the battery voltage is low.

### Load Short-circuiting Status

If voltage of VM pin is equal or below short-circuiting protection voltage ( $V_{SHORT}$ ), the RY2212 will stop discharging and battery is disconnected from load. The maximum delay time to switch current off is  $t_{SHORT}$ . This status is released when voltage of VM pin is higher than short protection voltage ( $V_{SHORT}$ ), such as when disconnecting the load.

### Delay Circuits

The detection delay time for over-discharge current and load short-circuiting starts when over-discharge current is detected. As soon as over-discharge current or load short-circuiting is detected over detection delay time for over-discharge current or load short-circuiting, the RY2212 stops discharging. When battery voltage falls below over-discharge detection voltage due to over-discharge current, the RY2212 stop discharging by over-discharge current detection. In this case the recovery of battery voltage is so slow that if battery voltage after over-discharge voltage detection delay time is still lower than over-discharge detection voltage, the RY2212 shifts to power-down.

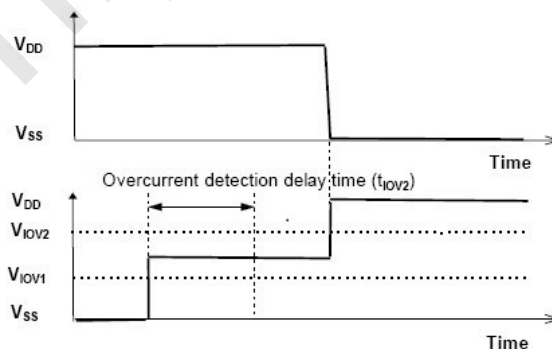

Figure 4. Overcurrent delay time





## Ry2212 One Cell Li-ion and Li-poly Battery Protection IC

### 0V Battery Charging Function (1) (2) (3)

This function enables the charging of a connected battery whose voltage is 0V by self-discharge. When a charger having 0V battery start charging charger voltage ( $V_{OCHA}$ ) or higher is connected between B+ and B- pins, the charging control FET gate is fixed to VDD potential. When the voltage between the gate and the source of the charging control FET becomes equal to or higher than the turn-on voltage by the charger voltage, the charging control FET is turned on to start charging. At this time, the discharging control FET is off and the charging current flows through the internal parasitic diode in the discharging control FET. If the battery voltage becomes equal to or higher than the overdischarge release voltage ( $V_{DU}$ ), the normal condition returns.

Note (1): Some battery providers do not recommend charging of completely discharged batteries. Please refer to battery providers before the selection of 0V battery charging function.

Note (2): The 0V battery charging function has higher priority than the abnormal charge current detection function. Consequently, a product with the 0V battery charging function charges a battery and abnormal charge current cannot be detected during the battery voltage is low (at most 1.8V or lower).

Note (3): When a battery is connected to the IC for the first time, the IC may not enter the normal condition in which discharging is possible. In this case, set the VM pin voltage equal to the GND voltage (short the VM and GND pins or connect a charger) to enter the normal condition.

## Ry2212 Timing Chart

### Overcharge and overdischarge detection

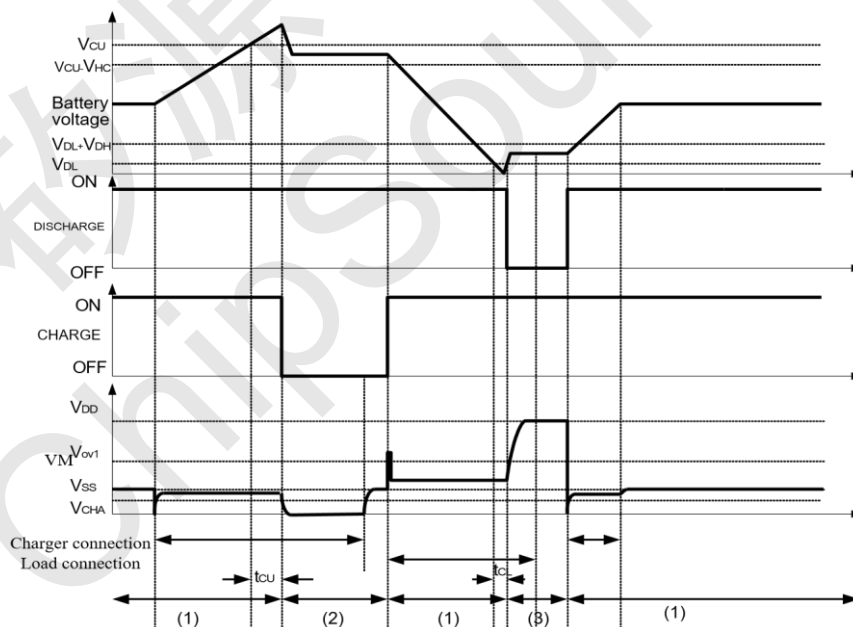

Figure5-1 Overcharge and Overdischarge Voltage Detection



## Ry2212 One Cell Li-ion and Li-poly Battery Protection IC

**Remark:**

- (1) Normal condition
- (2) Overcharge voltage condition
- (3) Overdischarge voltage condition
- (4) Overcurrent condition

### Overdischarge current detection

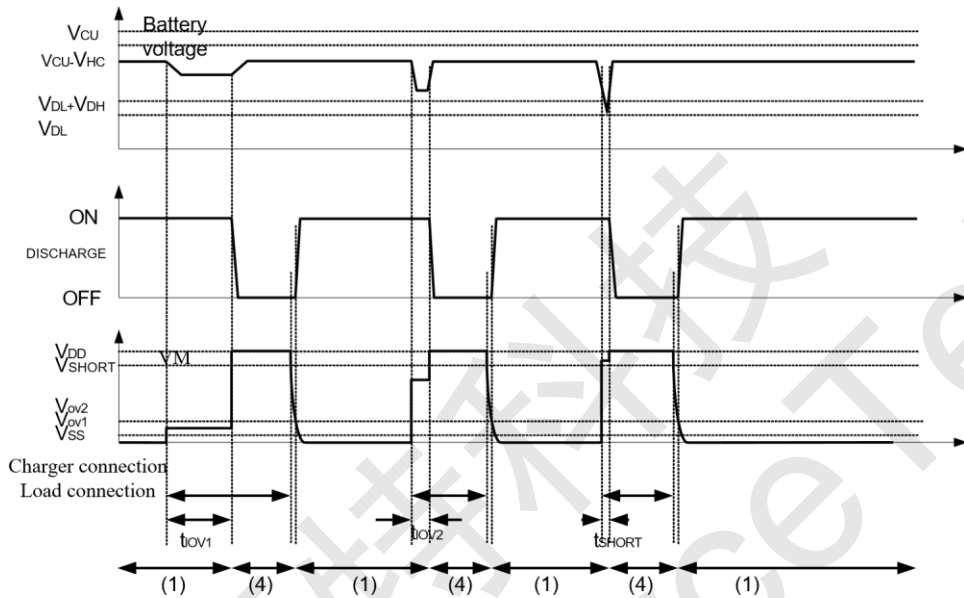

Figure5-2 Overdischarge Current Detection

**Remark:**

- (1) Normal condition
- (2) Overcharge voltage condition
- (3) Overdischarge voltage condition
- (4) Overcurrent condition

### Charger Detection

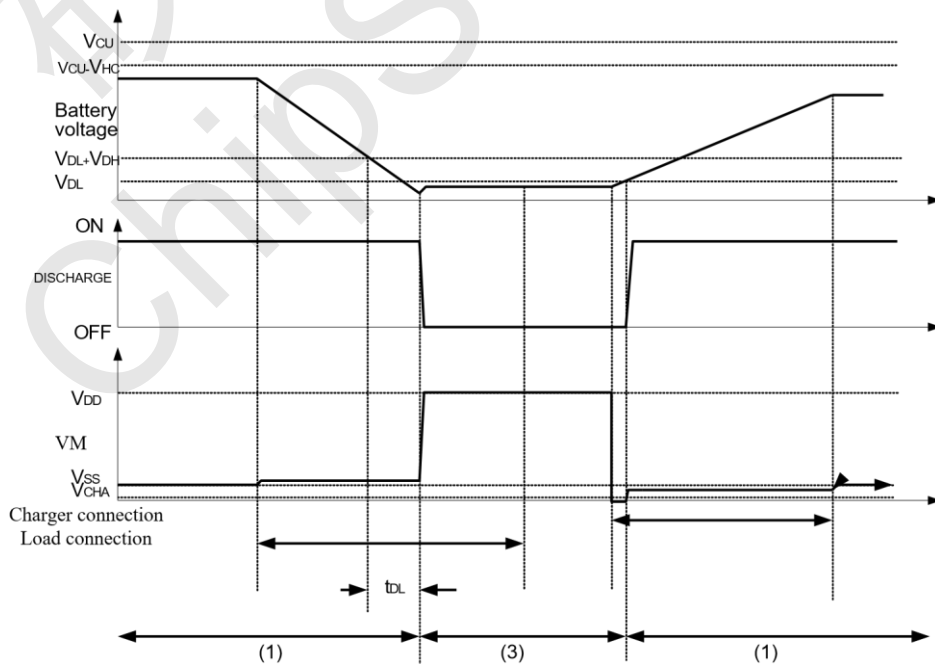

Figure5-3 Charger Detection



## Ry2212 One Cell Li-ion and Li-poly Battery Protection IC

**Remark:**

- (1) Normal condition
- (2) Overcharge voltage condition
- (3) Overdischarge voltage condition
- (4) Overcurrent condition

### Abnormal Charger Detection

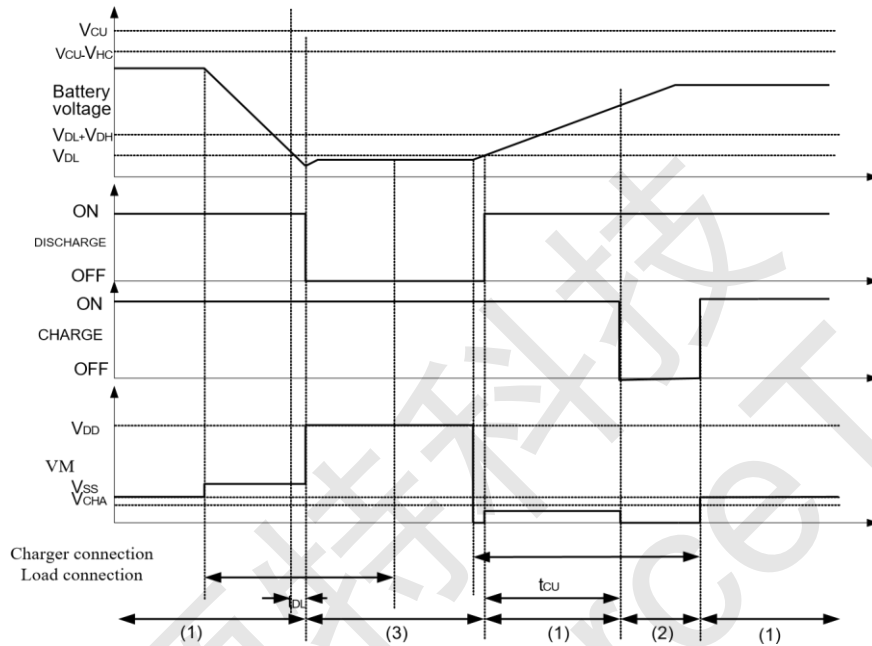

Figure5-4 Abnormal Charger Detection

**Remark:**

- (1) Normal condition
- (2) Overcharge voltage condition
- (3) Overdischarge voltage condition
- (4) Overcurrent condition

### Ry2212 Typical Application

As shown in Figure 1, the bold line is the high density current path which must be kept as short as possible. For thermal management, ensure that these trace widths are adequate. C1 & R1 is a decoupling capacitor & resistor which should be placed as close as possible to Ry2212.

### Precautions

- Pay attention to the operating conditions for input/output voltage and load current so that the power loss in Ry2212 does not exceed the power dissipation of the package.
- Do not apply an electrostatic discharge to this Ry2212 that exceeds the performance ratings of the built-in electrostatic protection circuit.



## RY2212 One Cell Li-ion and Li-poly Battery Protection IC

### RY2212 Package Description

#### ESOP8 (EXPOSED PAD)

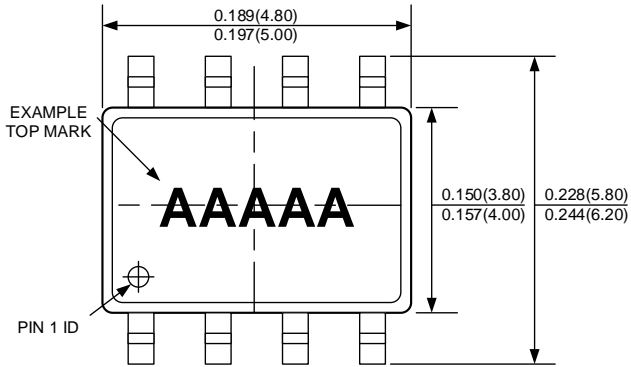

TOP VIEW

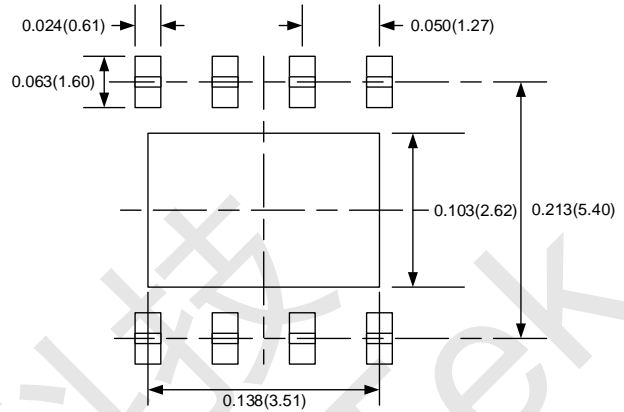

RECOMMENDED PAD LAYOUT

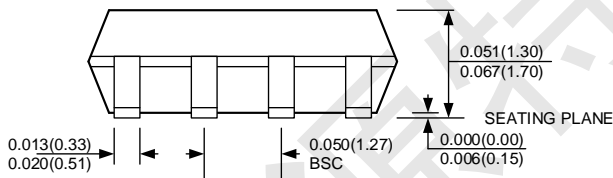

FRONT VIEW

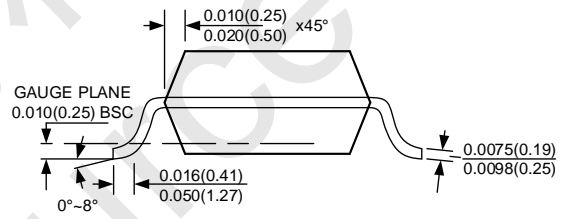

SIDE VIEW

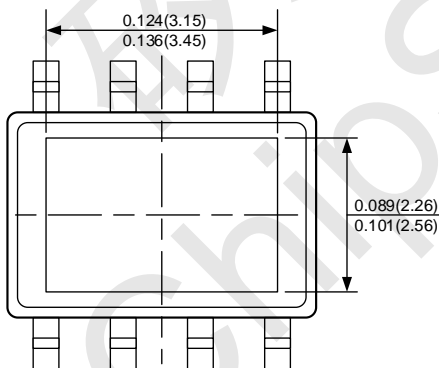

BOTTOM VIEW

**NOTE:**

1. CONTROL DIMENSION IS IN INCHES. DIMENSION IN BRACKET IS IN MILLIMETERS.
2. PACKAGE LENGTH DOES NOT INCLUDE MOLD FLASH, PROTRUSIONS OR GATE BURRS.
3. PACKAGE WIDTH DOES NOT INCLUDE INTERLEAD FLASH OR PROTRUSIONS.
4. LEAD COPLANARITY (BOTTOM OF LEADS AFTER FORMING) SHALL BE 0.004" INCHES MAX.
5. DRAWING CONFORMS TO JEDEC MS-012, VARIATION BA.
6. DRAWING IS NOT TO SCALE.