



PE01P18KT P-Channel Enhancement Mode Power MOSFET

PE01P18KT Description

The PE01P18KT uses advanced trench technology to provide excellent $R_{DS(ON)}$ and low gate charge. It can be used in a wide variety of applications.

PE01P18KT General Features

- $V_{DS} = -100V$, $I_D = -18A$
- $R_{DS(ON)} < 90m\Omega$ @ $V_{GS} = -10V$
- $R_{DS(ON)} < 100m\Omega$ @ $V_{GS} = -4.5V$
- High Power and current handing capability
- Lead free product is acquired
- Surface Mount Package

PE01P18KT Application

- PWM applications
- Load switch
- Power management

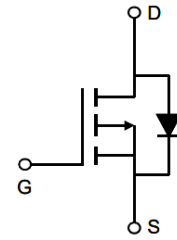

Schematic diagram

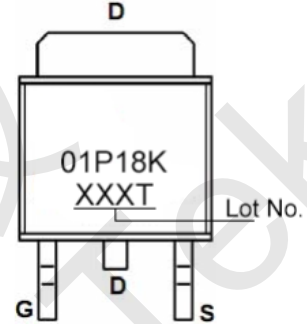

Marking and pin assignment

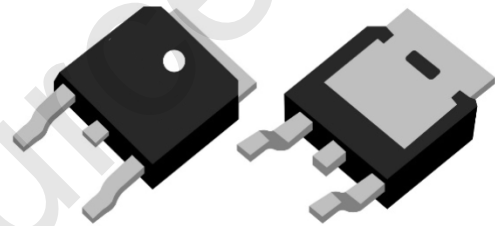

TO-252-2L

PE01P18KT Absolute Maximum Ratings (TC=25°C unless otherwise noted)

Parameter	Symbol	Rating	Unit
Drain-Source Voltage	V_{DS}	-100	V
Gate-Source Voltage	V_{GS}	± 20	V
Drain Current-Continuous	I_D	-18	A
Drain Current-Continuous (TC=100°C)	I_D	-12	A
Pulsed Drain Current (Note 1)	I_{DM}	-100	A
Maximum Power Dissipation	P_D	50	W
Avalanche Energy (L=0.1mH)	E_{AS}	97	mJ
Operating Junction and Storage Temperature Range	T_J, T_{STG}	-55 To 175	°C

PE01P18KT Thermal Characteristic

Thermal Resistance, Junction-to-Case	$R_{\theta JC}$	3	°C/W
--------------------------------------	-----------------	---	------



PE01P18KT Electrical Characteristics (TC=25°C unless otherwise noted)

Parameter	Symbol	Condition	Min	Typ	Max	Unit
Off Characteristics						
Drain-Source Breakdown Voltage	BV_{DSS}	$V_{GS}=0V, I_D=-250\mu A$	-100	-	-	V
Zero Gate Voltage Drain Current	I_{DSS}	$V_{DS}=-100V, V_{GS}=0V$	-	-	-1	μA
Gate-Body Leakage Current	I_{GSS}	$V_{GS}=\pm 20V, V_{DS}=0V$	-	-	± 100	nA
On Characteristics (Note 3)						
Gate Threshold Voltage	$V_{GS(th)}$	$V_{DS}=V_{GS}, I_D=-250\mu A$	-1.4	-2	-2.5	V
Drain-Source On-State Resistance	$R_{DS(ON)}$	$V_{GS}=-10V, I_D=-8A$	-	75	90	m Ω
		$V_{GS}=-4.5V, I_D=-5A$	-	80	100	m Ω
Dynamic Characteristics (Note 4)						
Input Capacitance	C_{iss}	$V_{DS}=-50V, V_{GS}=0V,$ $F=1.0MHz$	-	4300	-	pF
Output Capacitance	C_{oss}		-	4000	-	pF
Reverse Transfer Capacitance (Note 4)	C_{rss}		-	1800	-	pF
Switching Characteristics						
Turn-on Delay Time	$t_{d(on)}$	$V_{DD}=-50V, I_D=-8A,$ $V_{GS}=-10V, R_G=3\Omega$	-	16	-	nS
Turn-on Rise Time	t_r		-	73	-	nS
Turn-Off Delay Time	$t_{d(off)}$		-	34	-	nS
Turn-Off Fall Time	t_f		-	57	-	nS
Total Gate Charge	Q_g	$V_{DS}=-50V, I_D=-8A, V_{GS}=-10V$	-	61	-	nC
Gate-Source Charge	Q_{gs}		-	14	-	nC
Gate-Drain Charge	Q_{gd}		-	15	-	nC
Drain-Source Diode Characteristics						
Diode Forward Voltage (Note 3)	V_{SD}	$V_{GS}=0V, I_S=-1A$	-	-	-1.2	V
Maximum Body-Diode Current	I_S		-	-	-18	A

Notes:

1. Repetitive Rating: Pulse width limited by maximum junction temperature.
2. Surface Mounted on FR4 Board, $t \leq 10$ sec.
3. Pulse Test: Pulse Width $\leq 300\mu s$, Duty Cycle $\leq 2\%$.
4. Guaranteed by design, not subject to product.



PE01P18KT Typical Electrical and Thermal Characteristics

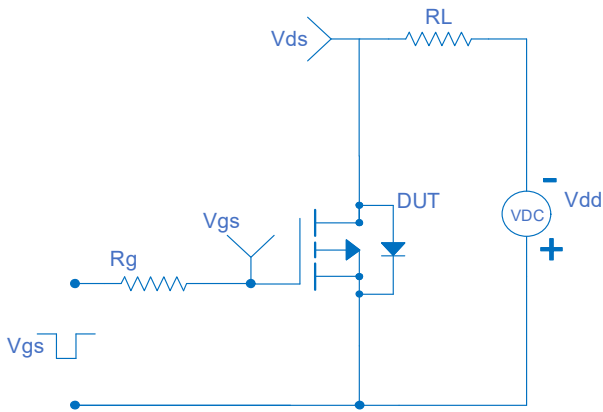

Figure 1 Switching Test Circuit

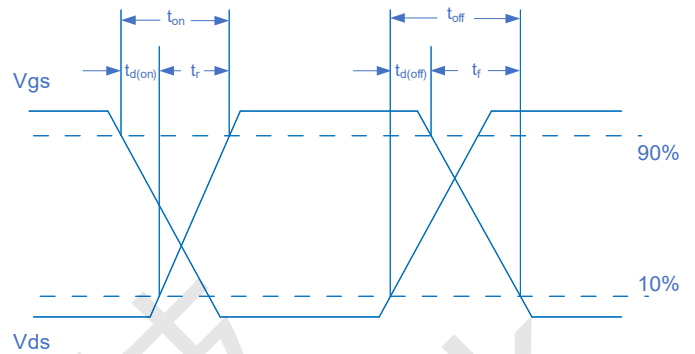

Figure 2 Switching Waveform

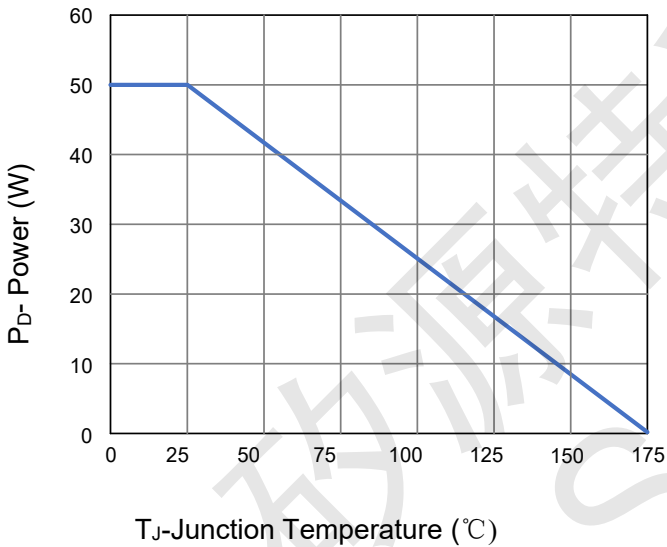

Figure 3 Power De-rating

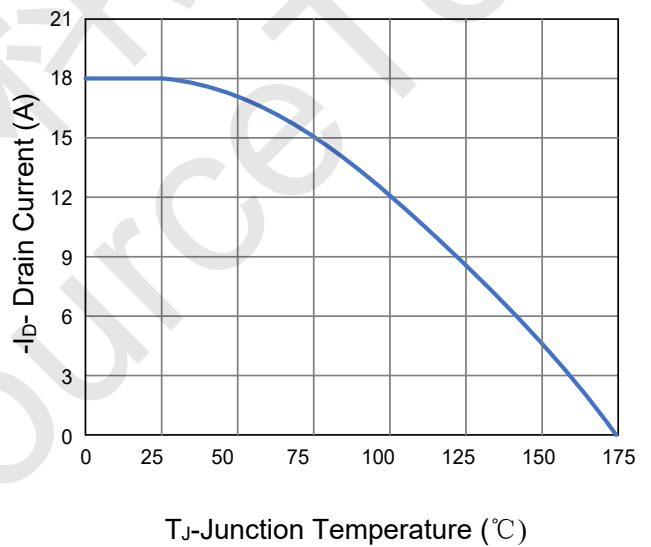

Figure 4 Drain Current

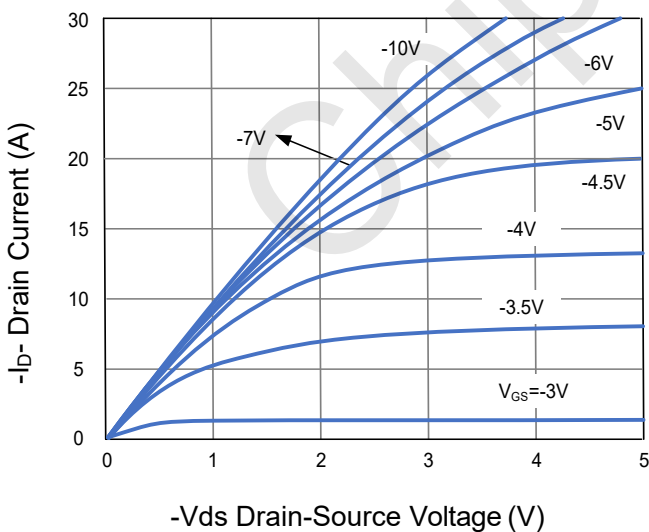

Figure 5 Output Characteristics

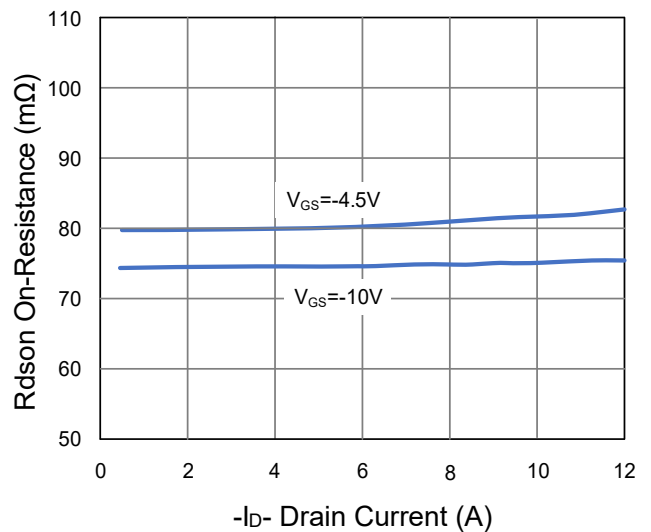

Figure 6 Rdson vs Drain Current

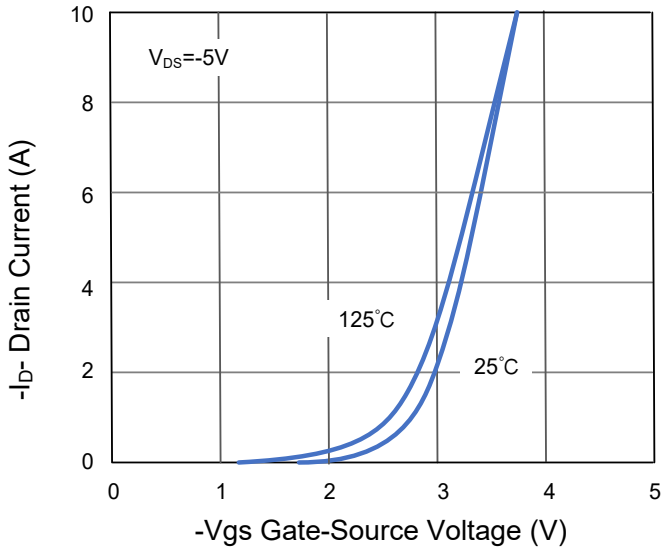

Figure 7 Transfer Characteristics

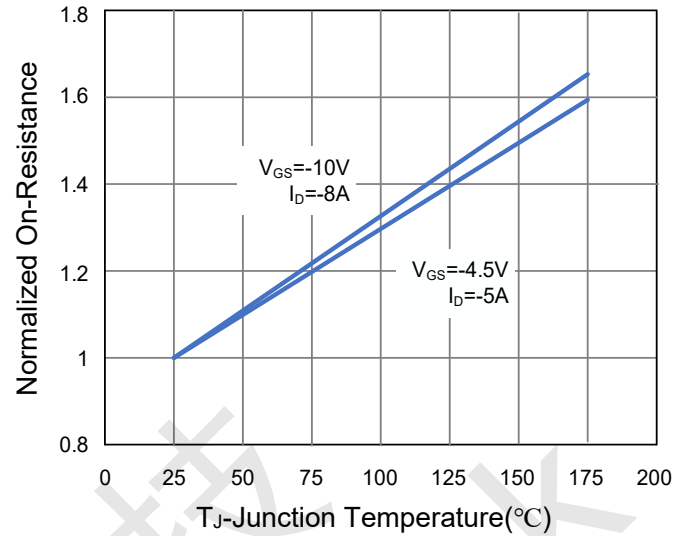

Figure 8 Rdson vs Junction Temperature

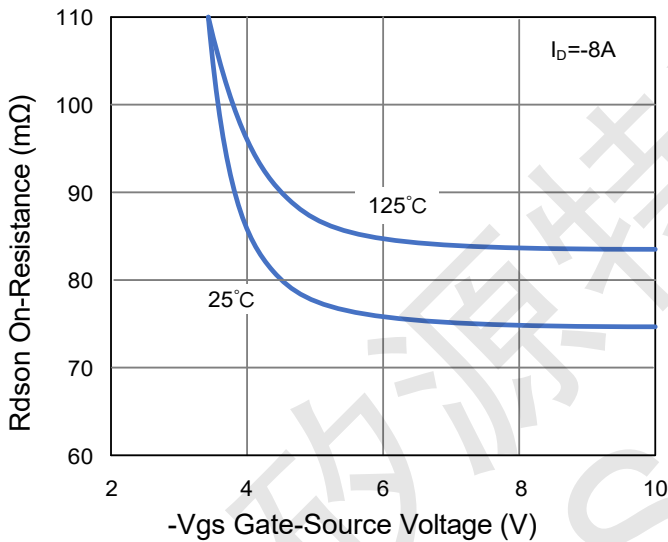

Figure 9 Rdson vs Vgs

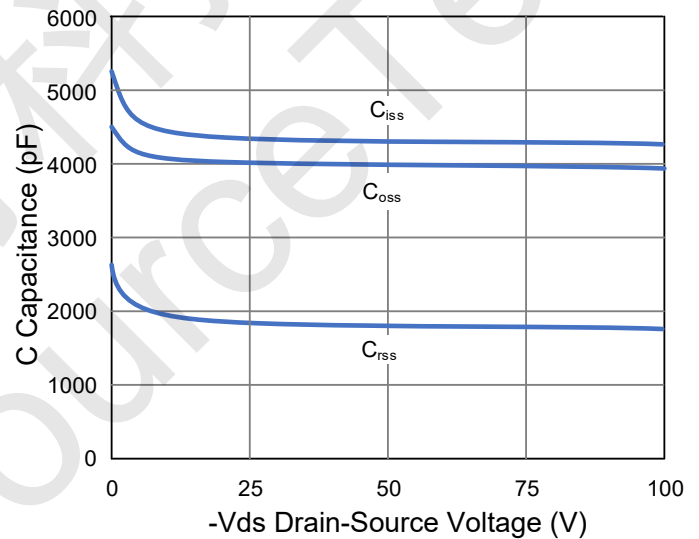

Figure 10 Capacitance vs Vds

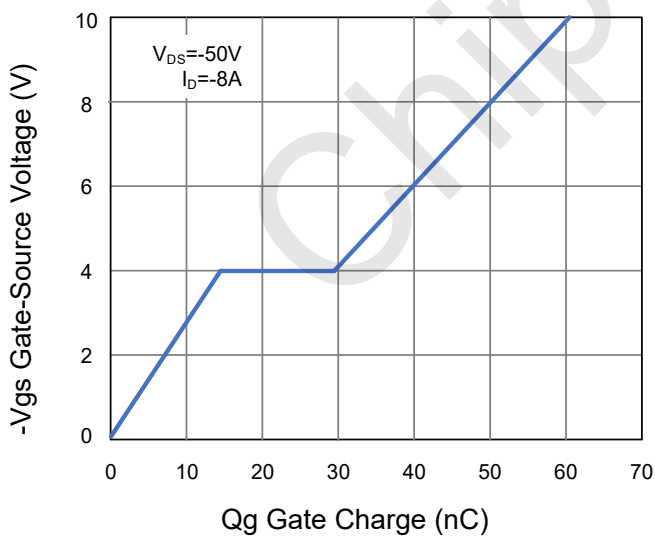

Figure 11 Gate Charge

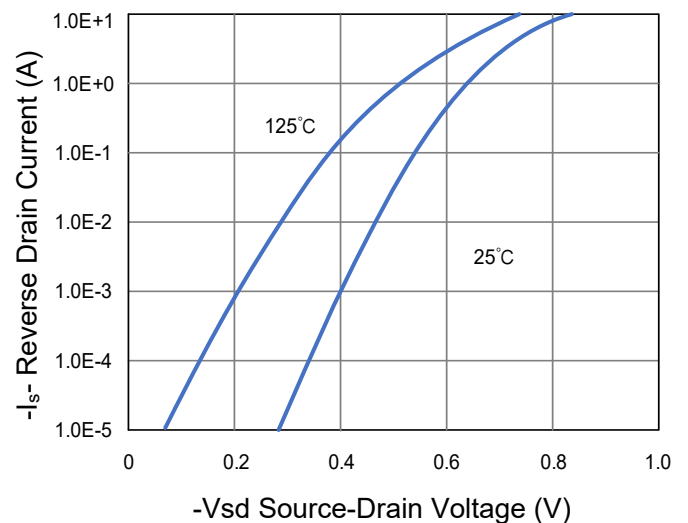

Figure 12 Source- Drain Diode Forward

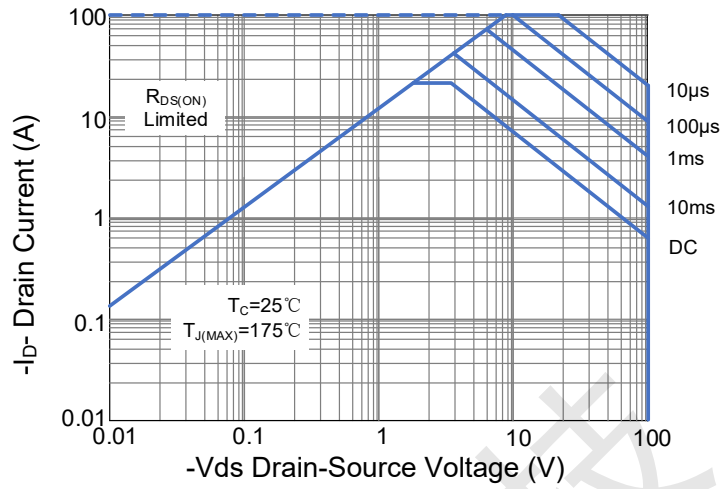

Figure 13 Safe Operation Area

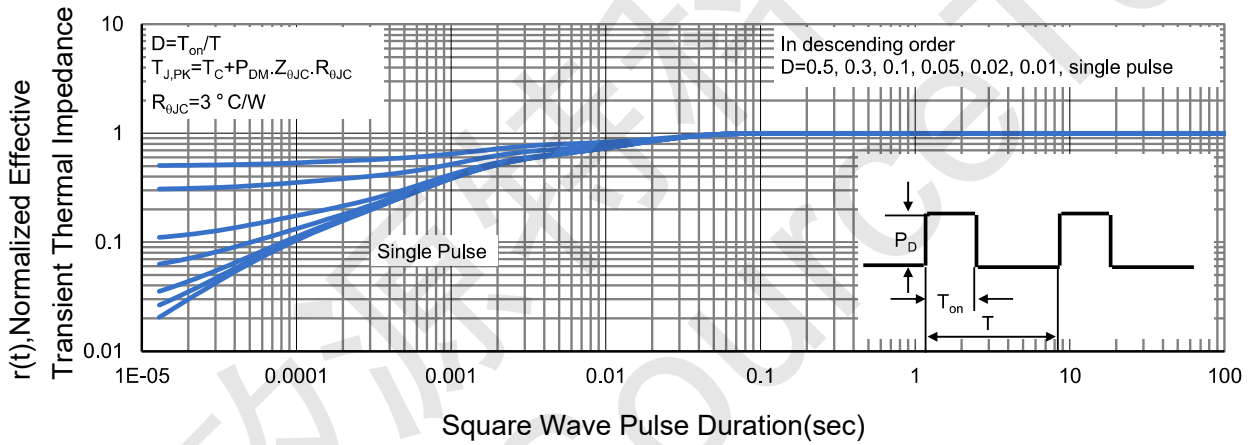
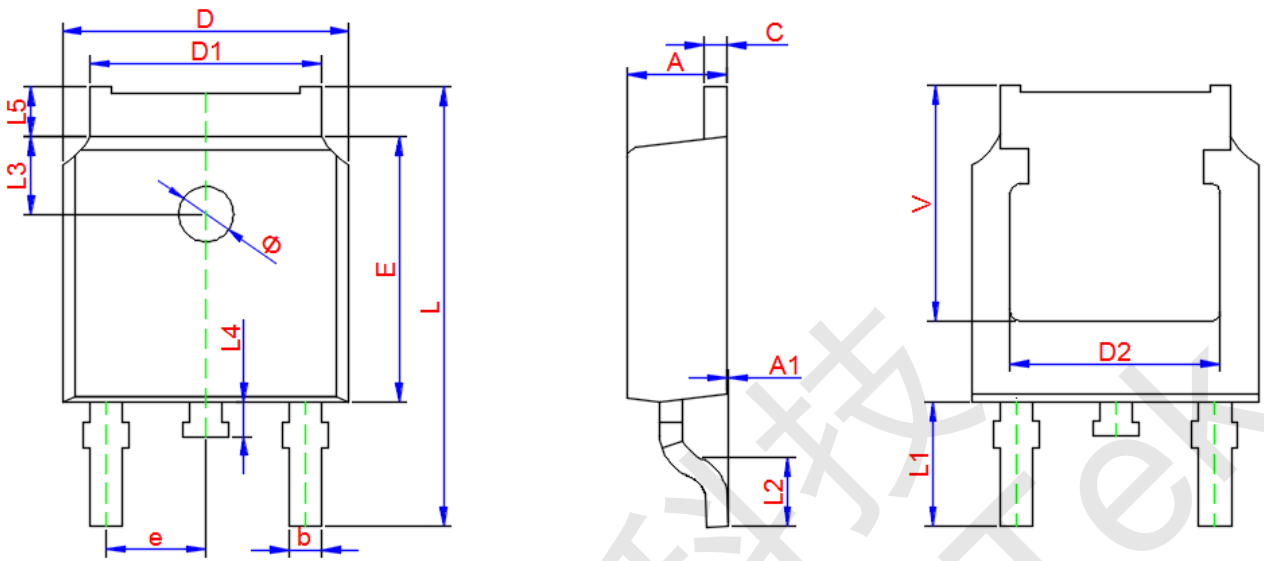

Figure 14 Normalized Maximum Transient Thermal Impedance



PE01P18KT TO-252-2L Package Information



Symbol	Dimensions In Millimeters		
	Min.	Typ.	Max.
A	2.200	2.300	2.400
A1	0.000	--	0.127
b	0.660	0.760	0.860
D	6.500	6.600	6.700
D1	5.100	5.330	5.460
C	0.450	0.500	0.600
D2	4.830 TYP.		
E	6.000	6.100	6.200
e	2.186	2.286	2.386
L	9.800	10.100	10.400
L1	2.900 TYP.		
L2	1.400	1.500	1.600
L3	1.800 TYP.		
L4	0.600	0.800	1.000
L5	0.900	--	1.250
Φ	1.100.	--	1.300
θ	0°	--	8°
V	5.350		