



CSTT90N20T N-Ch 200V Fast Switching MOSFETs

- ★ Super Low Gate Charge
- ★ 100% EAS Guaranteed
- ★ Green Device Available
- ★ Excellent CdV/dt effect decline
- ★ Advanced high cell density Trench technology

CSTT90N20T Product Summary



BVDSS	RDSON	ID
200V	23 mΩ	90A

CSTT90N20T TO220 Pin Configuration

CSTT90N20T Description

The CSTT90N20T is the high cell density trenched N-ch MOSFETs, which provide excellent RDSON and gate charge for most of the synchronous buck converter applications. The CSTT90N20T meet the RoHS and Green Product requirement, 100% EAS guaranteed with full function reliability approved.

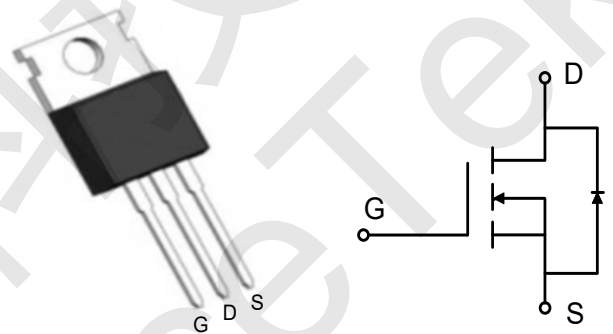

CSTT90N20T Absolute Maximum Ratings (T_C= 25°C unless otherwise specified) :

Symbol	Parameter	Rating	Unit
Common Ratings (T_C=25°C Unless Otherwise Noted)			
V _{DSS}	Drain-Source Voltage	200	V
V _{GSS}	Gate-Source Voltage	±20	V
T _J	Maximum Junction Temperature	175	°C
T _{STG}	Storage Temperature Range	-55 to 175	°C
I _S	Source Current-Continuous(Body Diode)	T _C =25°C 90	A
Mounted on Large Heat Sink			
I _{DM}	Pulsed Drain Current *	T _C =25°C 360	A
I _D	Continuous Drain Current	T _C =25°C 90	A
		T _C =100°C 64	A
P _D	Maximum Power Dissipation	T _C =25°C 375	W
		T _C =100°C 187.5	W
R _{θJC}	Thermal Resistance, Junction-to-Case	0.4	°C/W
R _{θJA}	Thermal Resistance, Junction-to-Ambient **	40	°C/W
E _{AS}	Single Pulsed-Avalanche Energy ***	L=0.5mH 833	mJ



CSTT90N20T Electrical Characteristics (T_c =25°C Unless Otherwise Noted)

Symbol	Parameter	Test Conditions	HY1920			Unit
			Min	Typ.	Max	
Static Characteristics						
BV _{DSS}	Drain-Source Breakdown Voltage	V _{GS} =0V, I _{DS} =250μA	200	-	-	V
I _{DSS}	Drain-to-Source Leakage Current	V _{DS} =200V, V _{GS} =0V	-	-	1	μA
		T _J =55°C	-	-	5	μA
V _{GS(th)}	Gate Threshold Voltage	V _{DS} =V _{GS} , I _{DS} =250μA	2.0	3.0	4.0	V
I _{GSS}	Gate-Source Leakage Current	V _{GS} =±20V, V _{DS} =0V	-	-	±100	nA
R _{DS(ON)*}	Drain-Source On-State Resistance	V _{GS} =10V, I _{DS} =45A	-	23	25	mΩ
Diode Characteristics						
V _{SD*}	Diode Forward Voltage	I _{SD} =45A, V _{GS} =0V	-	0.85	1.2	V
t _{rr}	Reverse Recovery Time	I _{SD} =45A, dI _{SD} /dt=100A/μs	-	80	-	ns
Q _{rr}	Reverse Recovery Charge		-	160	-	nC

CSTT90N20T Electrical Characteristics (Cont.) (T_c =25°C Unless Otherwise Noted)

Symbol	Parameter	Test Conditions	HY1920			Unit
			Min	Typ.	Max	
Dynamic Characteristics						
R _G	Gate Resistance	V _{GS} =0V, V _{DS} =0V, F=1MHz	-	3.4	-	Ω
C _{iss}	Input Capacitance	V _{GS} =0V, V _{DS} =25V, Frequency=1.0MHz	-	5871	-	pF
C _{oss}	Output Capacitance		-	392	-	
C _{rss}	Reverse Transfer Capacitance		-	165	-	
t _{d(ON)}	Turn-on Delay Time		V _{DD} =100V, R _G =4Ω, I _{DS} =45A, V _{GS} =10V	-	29	-
T _r	Turn-on Rise Time	-		45	-	
t _{d(OFF)}	Turn-off Delay Time	-		22	-	
T _f	Turn-off Fall Time	-		41	-	
Gate Charge Characteristics						
Q _g	Total Gate Charge	V _{DS} =100V, V _{GS} =10V, I _D =30A	-	130	-	nC
Q _{gs}	Gate-Source Charge		-	22	-	
Q _{gd}	Gate-Drain Charge		-	38	-	

a1: Repetitive rating; pulse width limited by maximum junction temperature



CSTT90N20T Typical Operating Characteristic

Figure 1: Power Dissipation

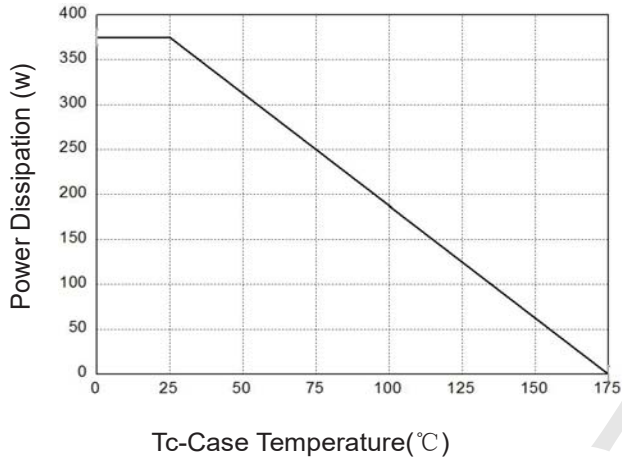

Figure 2: Drain Current

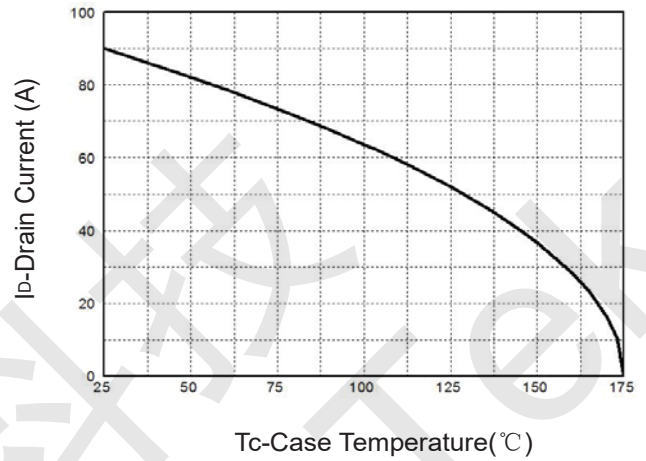

Figure 3: Safe Operation Area

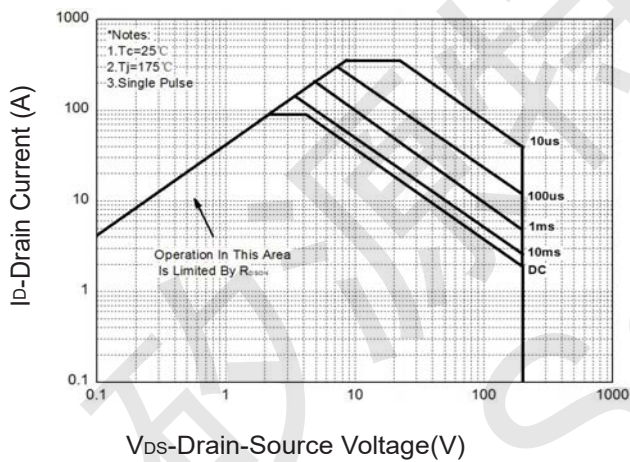

Figure 4: Thermal Transient Impedance

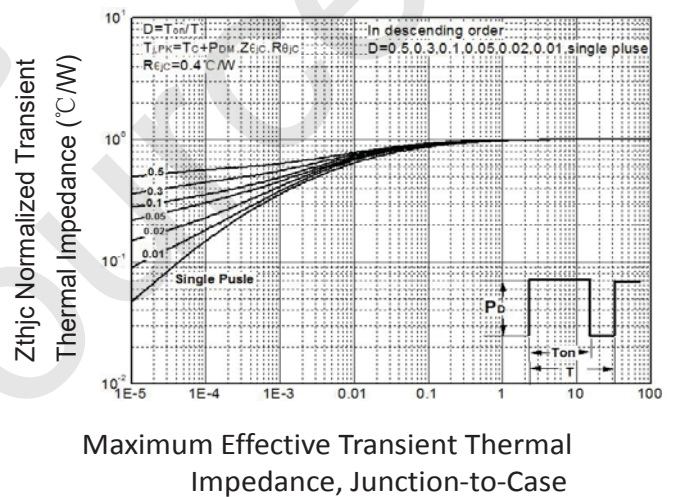

Figure 5: Output Characteristics

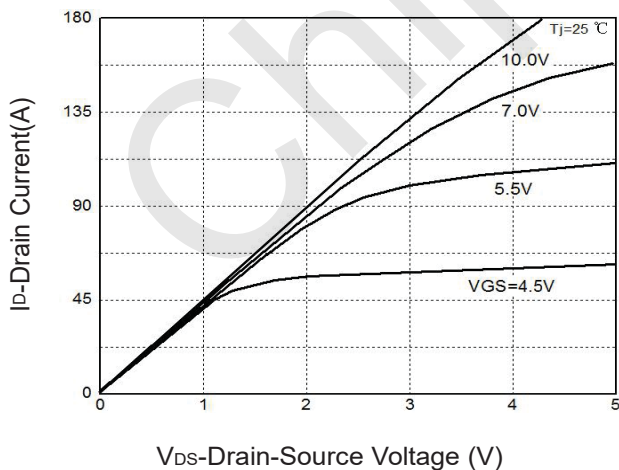
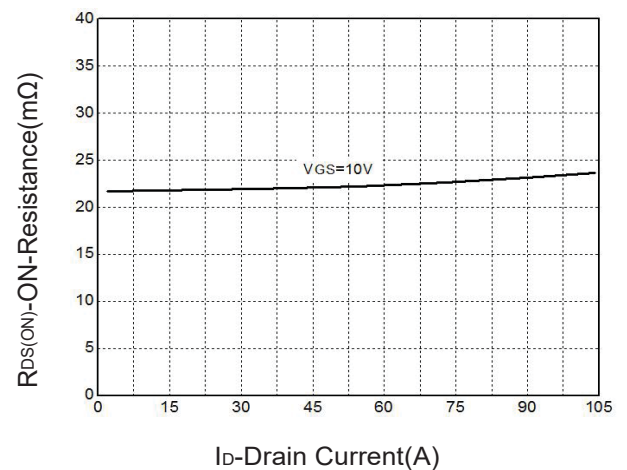

Figure 6: Drain-Source On Resistance





CSTT90N20T Typical Operating Characteristics(Cont.)

Figure 7: On-Resistance vs. Temperature

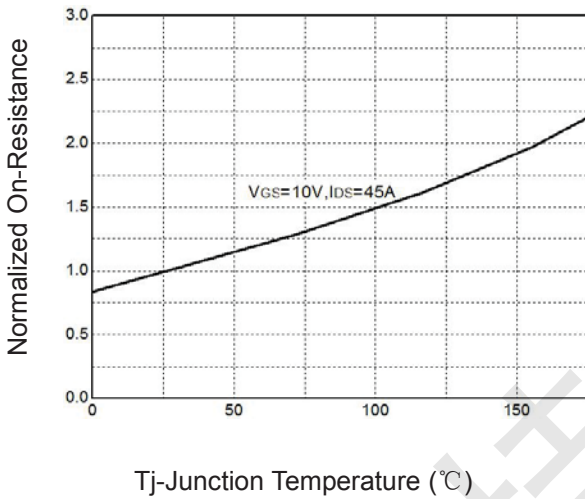

Figure 8: Source-Drain Diode Forward

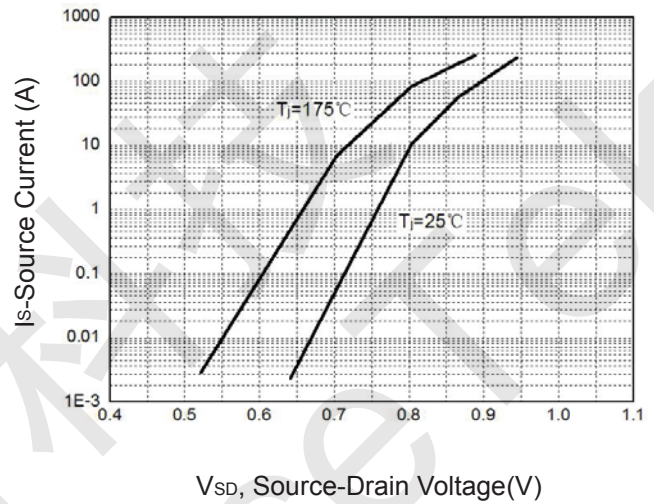

Figure 9: Capacitance Characteristics

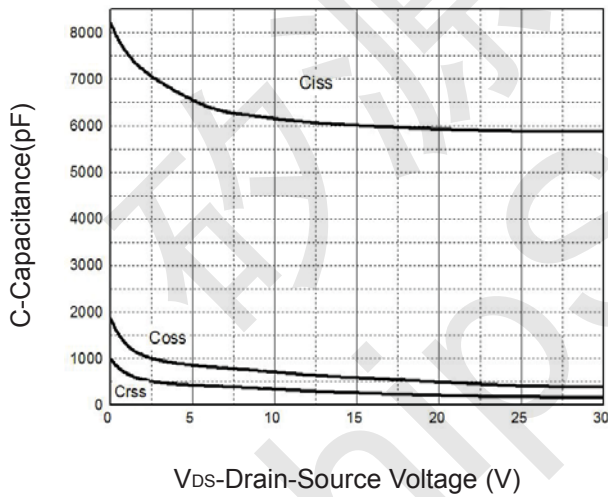
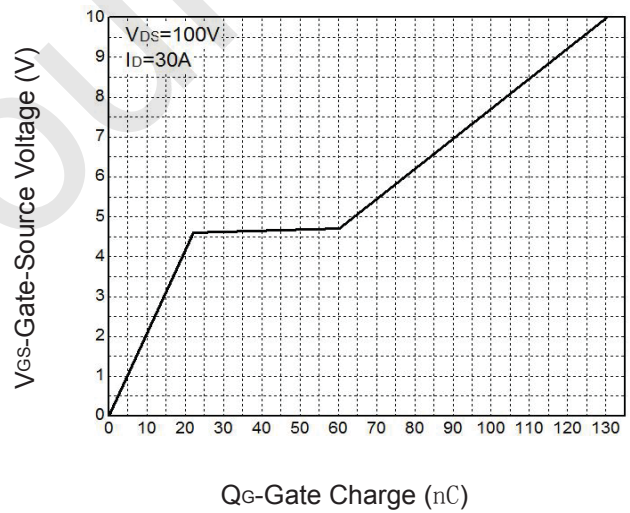
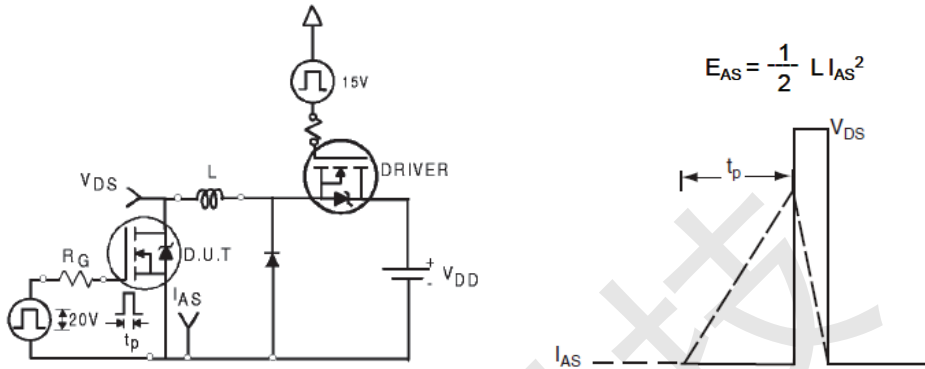

Figure 10: Gate Charge Characteristics





CSTT90N20T Avalanche Test Circuit



CSTT90N20T Switching Time Test Circuit

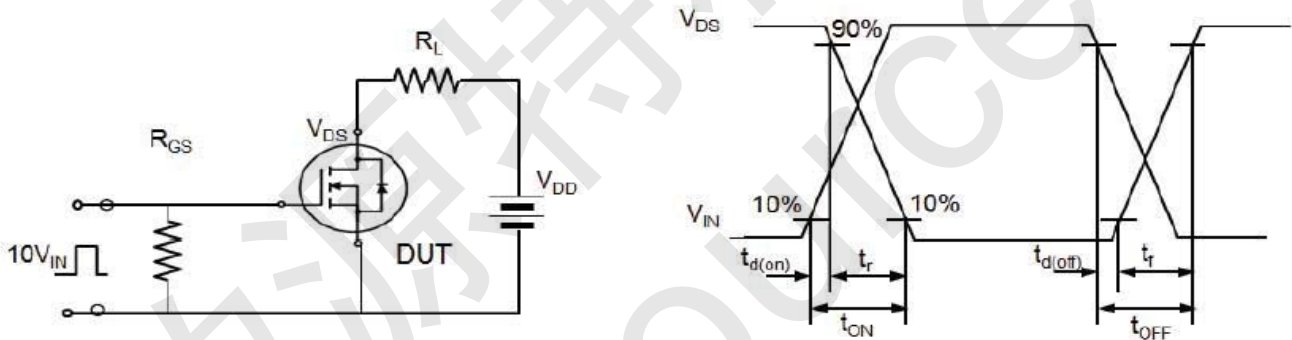

CSTT90N20T Gate Charge Test Circuit

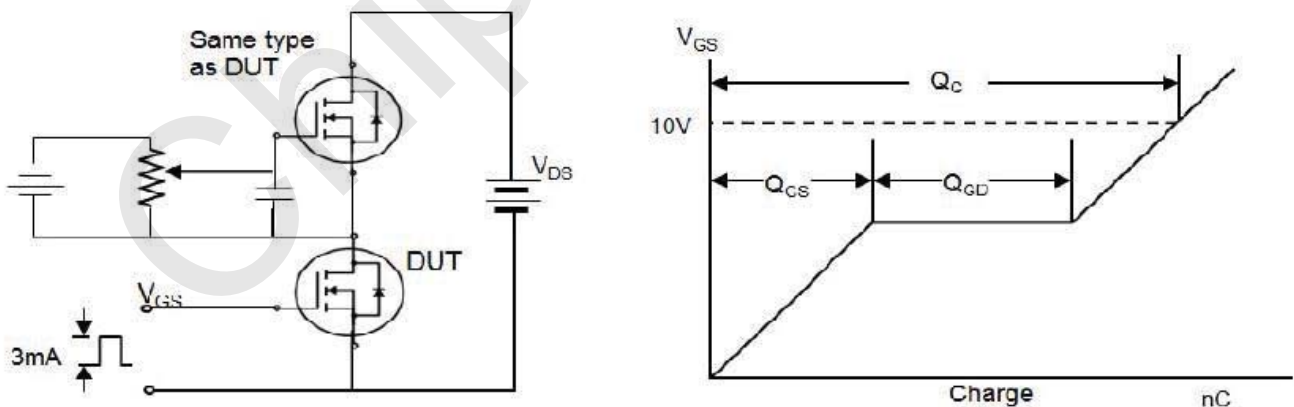



CSTT90N20T Mechanical Dimensions for TO-220

COMMON DIMENSIONS

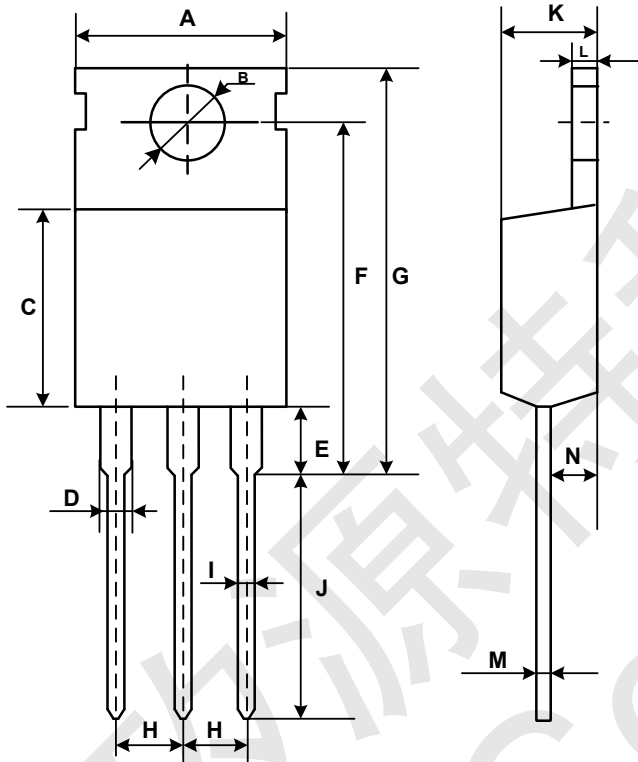

SYMBOL	MM	
	MIN	MAX
A	9.70	10.30
B	3.40	3.80
C	8.80	9.40
D	1.17	1.47
E	2.60	3.50
F	15.10	16.70
G	19.55MAX	
H	2.54REF	
I	0.70	0.95
J	9.35	11.00
K	4.30	4.77
L	1.20	1.45
M	0.40	0.65
N	2.20	2.60