



CST90P01D P-Ch 18V Fast Switching MOSFETs

- ★ Super Low Gate Charge
- ★ Green Device Available
- ★ Excellent CdV/dt effect decline
- ★ Advanced high cell density Trench technology

CST90P01D Product Summary



BVDSS	RDS(on)	ID
-20V	3.6mΩ	-90A

CST90P01D Description

The CST90P01D is the high cell density trenched P-ch MOSFETs, which provide excellent RDS(on) and gate charge for most of the synchronous buck converter applications.

The CST90P01D meet the RoHS and Green Product requirement with full function reliability approved.

CST90P01D TO252 Pin Configuration

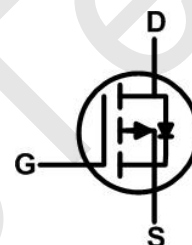
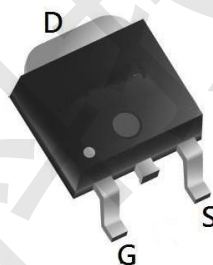

CST90P01D Absolute Maximum Ratings

Symbol	Parameter	Rating	Units
V _{DS}	Drain-Source Voltage	-20	V
V _{GS}	Gate-Source Voltage	±12	V
I _D @T _C =25°C	Continuous Drain Current, V _{GS} @ -4.5V ¹	-90	A
I _D @T _C =70°C	Continuous Drain Current, V _{GS} @ -4.5V ¹	-53	A
I _{DM}	Pulsed Drain Current ²	-280	A
P _D @T _C =25°C	Total Power Dissipation ³	62	W
P _D @T _C =70°C	Total Power Dissipation ³	35	W
T _{STG}	Storage Temperature Range	-55 to 150	°C
T _J	Operating Junction Temperature Range	-55 to 150	°C

CST90P01D Thermal Data

Symbol	Parameter	Max.	Unit
R _{θJA}	Thermal Resistance Junction-Ambient ¹	3	°C/W
R _{θJA}	Thermal Resistance Junction-Ambient ¹ (t ≤ 10s)		°C/W
R _{θJC}	Thermal Resistance Junction-Case ¹		°C/W



CST90P01D P-Ch 18V Fast Switching MOSFETs

CST90P01D Electrical Characteristics (T_J=25°C unless otherwise specified)

Symbol	Parameter	Test Condition	Min.	Typ.	Max.	Units
Off Characteristic						
V _{(BR)DSS}	Drain-Source Breakdown Voltage	V _{GS} =0V, I _D = -250μA	-20	-	-	V
I _{DSS}	Zero Gate Voltage Drain Current	V _{DS} = -20V, V _{GS} = 0V,	-	-	-1	μA
I _{GSS}	Gate to Body Leakage Current	V _{DS} =0V, V _{GS} = ±12V	-	-	±100	nA
On Characteristics						
V _{GS(th)}	Gate Threshold Voltage	V _{DS} = V _{GS} , I _D = -250μA	-0.35	-0.65	-1.0	V
R _{DS(on)}	Static Drain-Source on-Resistance <small>note3</small>	V _{GS} =-4.5V, I _D =-15A	-	3.6	5.5	mΩ
		V _{GS} =-2.5V, I _D =-12A	-	4.5	92	
Dynamic Characteristics						
C _{iss}	Input Capacitance	V _{DS} =-10V, V _{GS} =0V, f = 1.0MHz	-	6600	-	pF
C _{oss}	Output Capacitance		-	460	-	pF
C _{rss}	Reverse Transfer Capacitance		-	659	-	pF
Q _g	Total Gate Charge	V _{DS} =-10V, I _D =-15A, V _{GS} =-4.5V	-	76	-	nC
Q _{gs}	Gate-Source Charge		-	10	-	nC
Q _{gd}	Gate-Drain("Miller") Charge		-	20	-	nC
Switching Characteristics						
t _{d(on)}	Turn-on Delay Time	V _{DD} =-10V, I _D =-13A, R _{GEN} =2.7Ω, V _{GS} =-10V	-	14	-	ns
t _r	Turn-on Rise Time		-	130	-	ns
t _{d(off)}	Turn-off Delay Time		-	187	-	ns
t _f	Turn-off Fall Time		-	190	-	ns
Drain-Source Diode Characteristics and Maximum Ratings						
I _S	Maximum Continuous Drain to Source Diode Forward Current		-	-	-90	A
I _{SM}	Maximum Pulsed Drain to Source Diode Forward Current		-	-	-280	A
V _{SD}	Drain to Source Diode Forward Voltage	V _{GS} = 0V, I _S =-30A	-	-	-1.2	V
trr	Reverse Recovery Time	T _J =25°C, I _{SD} =-15A,	-	23	-	ns
Qrr	Reverse Recovery Charge	V _{GS} =0V di/dt=-100A/μs	-	14	-	Nc

Notes:1. Repetitive Rating: Pulse Width Limited by Maximum Junction Temperature

2. EAS condition: T_J=25°C, V_{DD}=-10V, V_G=-10V, R_G=5.9Ω, L=0.5mh, I_{AS}=-16A

3. Pulse Test: Pulse Width≤300μs, Duty Cycle≤0.5%



CST90P01D Typical Performance Characteristics

Figure 1: Output Characteristics

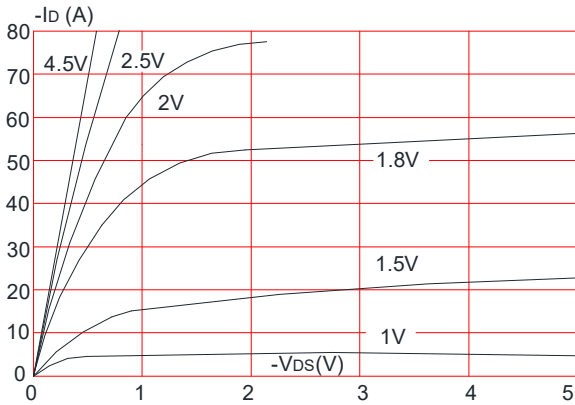

Figure 2: Typical Transfer Characteristics

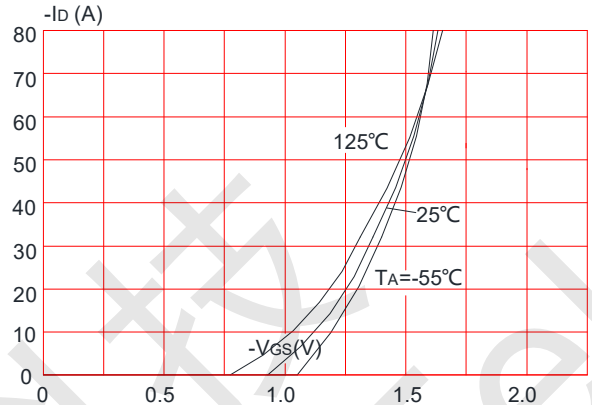

Figure 3: On-resistance vs. Drain Current

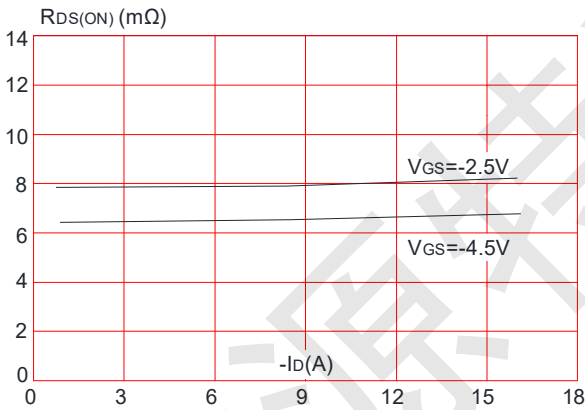

Figure 4: Body Diode Characteristics

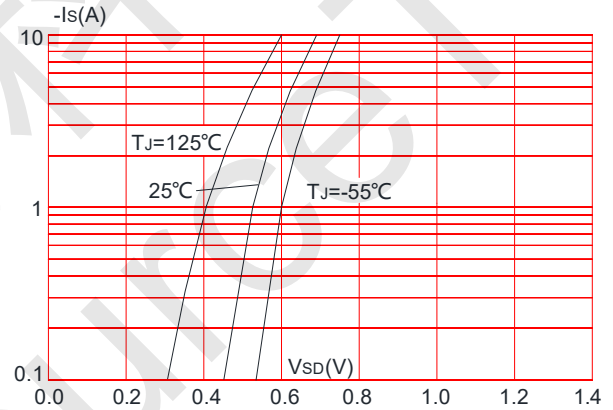

Figure 5: Gate Charge Characteristics

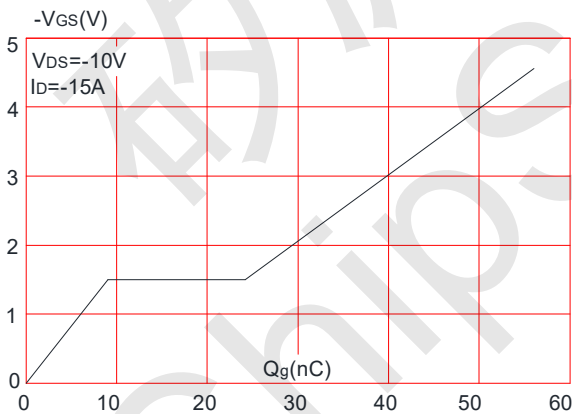
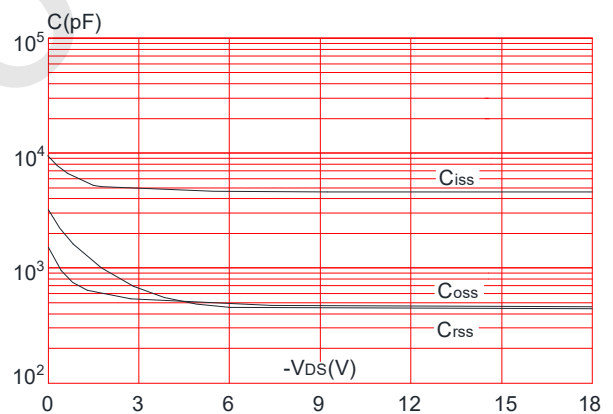

Figure 6: Capacitance Characteristics





CST90P01D P-Ch 18V Fast Switching MOSFETs

Figure 7: Normalized Breakdown Voltage vs. Junction Temperature

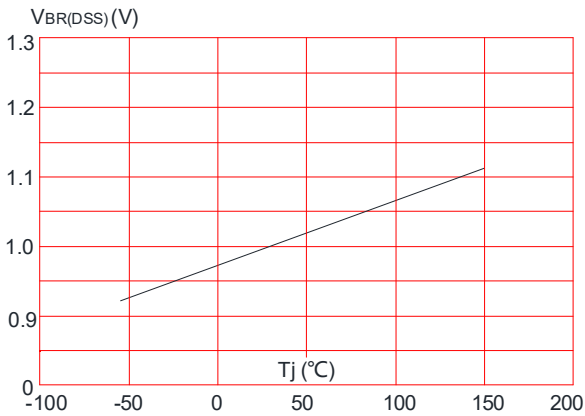

Figure 8: Normalized on Resistance vs. Junction Temperature

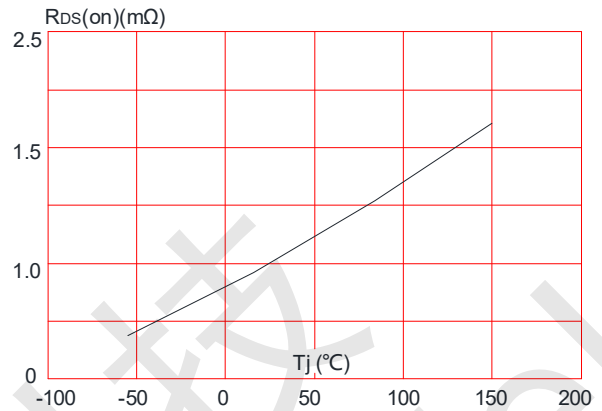

Figure 9: Maximum Safe Operating Area

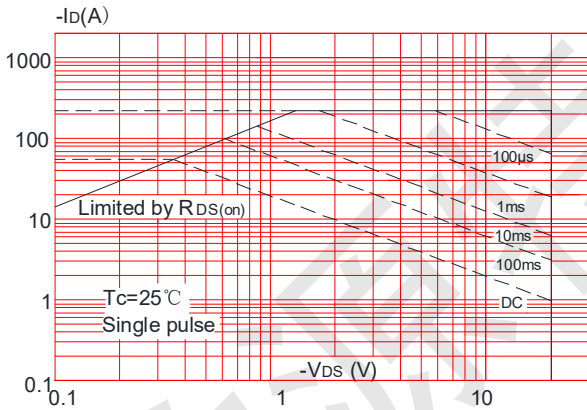

Figure 10: Maximum Continuous Drain Current vs. Case Temperature

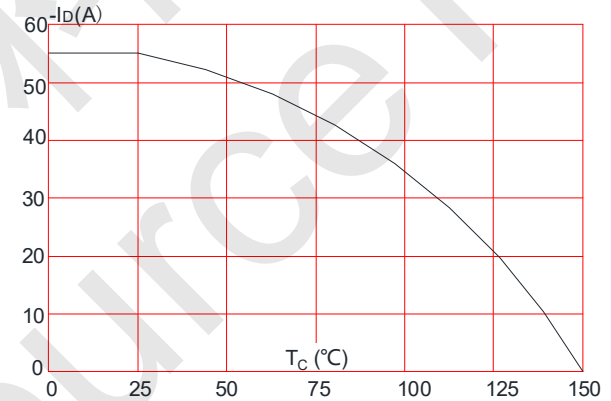
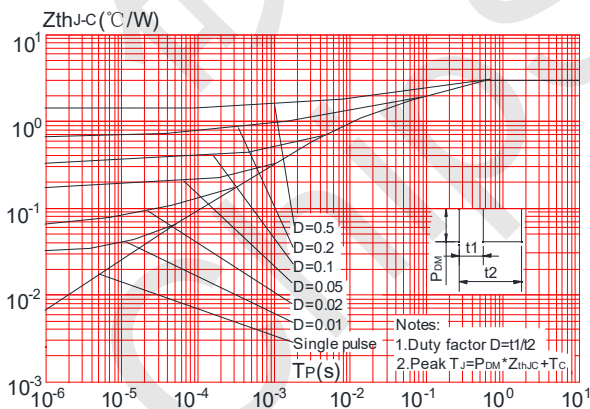

Figure.11: Maximum Effective Transient Thermal Impedance, Junction-to-Case





CST90P01D P-Ch 18V Fast Switching MOSFETs

CST90P01D Package Mechanical Data-TO-252-4R

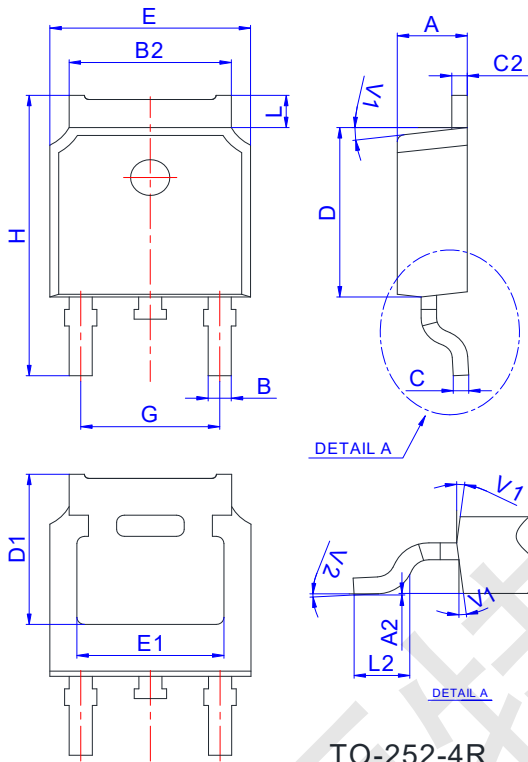

Ref.	Dimensions					
	Millimeters			Inches		
	Min.	Typ.	Max.	Min.	Typ.	Max.
A	2.10		2.50	0.083		0.098
A2	0		0.10	0		0.004
B	0.66		0.86	0.026		0.034
B2	5.18		5.48	0.202		0.216
C	0.40		0.60	0.016		0.024
C2	0.44		0.58	0.017		0.023
D	5.90		6.30	0.232		0.248
D1	5.30REF			0.209REF		
E	6.40		6.80	0.252		0.268
E1	4.63			0.182		
G	4.47		4.67	0.176		0.184
H	9.50		10.70	0.374		0.421
L	1.09		1.21	0.043		0.048
L2	1.35		1.65	0.053		0.065
V1		7°			7°	
V2	0°		6°	0°		6°

Reel Specification-TO-252-4R

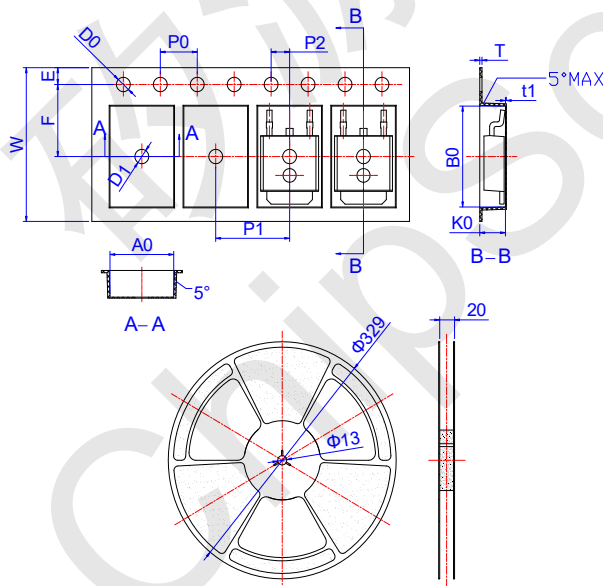

Ref.	Dimensions					
	Millimeters			Inches		
	Min.	Typ.	Max.	Min.	Typ.	Max.
W	15.90	16.00	16.10	0.626	0.630	0.634
E	1.65	1.75	1.85	0.065	0.069	0.073
F	7.40	7.50	7.60	0.291	0.295	0.299
D0	1.40	1.50	1.60	0.055	0.059	0.063
D1	1.40	1.50	1.60	0.055	0.059	0.063
P0	3.90	4.00	4.10	0.154	0.157	0.161
P1	7.90	8.00	8.10	0.311	0.315	0.319
P2	1.90	2.00	2.10	0.075	0.079	0.083
A0	6.85	6.90	7.00	0.270	0.271	0.276
B0	10.45	10.50	10.60	0.411	0.413	0.417
K0	2.68	2.78	2.88	0.105	0.109	0.113
T	0.24		0.27	0.009		0.011
t1	0.10			0.004		
10P0	39.80	40.00	40.20	1.567	1.575	1.583