



CST90N02F N-Ch 20V Fast Switching MOSFETs

- ★ 100% EAS Guaranteed
- ★ Green Device Available
- ★ Super Low Gate Charge
- ★ Excellent CdV/dt effect decline
- ★ Advanced high cell density Trench technology

CST90N02F Product Summary



BVDSS	RDSON	ID
20V	2.7mΩ	90A

CST90N02F Description

The CST90N02F is the high cell density trenched N-ch MOSFETs, which provide excellent RDSON and gate charge for most of the synchronous buck converter applications. The CST90N02F meet the RoHS and Green Product requirement, 100% EAS guaranteed with full function reliability approved.

CST90N02F PDFN5060-8L Pin Configuration



CST90N02F Absolute Maximum Ratings

Symbol	Parameter	Rating	Units
V_{DS}	Drain-Source Voltage	20	V
V_{GS}	Gate-Source Voltage	± 20	V
$I_D@T_C=25^\circ C$	Continuous Drain Current, $V_{GS} @ 10V^1$	90	A
$I_D@T_C=100^\circ C$	Continuous Drain Current, $V_{GS} @ 10V^1$	59	A
I_{DM}	Pulsed Drain Current ²	360	A
EAS	Single Pulse Avalanche Energy ³	118	mJ
I_{AS}	Avalanche Current	41	A
$P_D@T_C=25^\circ C$	Total Power Dissipation ⁴	88	W
T_{STG}	Storage Temperature Range	-55 to 150	$^\circ C$
T_J	Operating Junction Temperature Range	-55 to 150	$^\circ C$

CST90N02F Thermal Data

Symbol	Parameter	Typ.	Max.	Unit
$R_{\theta JC}$	Thermal Resistance Junction-Case ¹	---	1.8	$^\circ C/W$



CST90N02F N-Ch 20V Fast Switching MOSFETs

CST90N02F Electrical Characteristics (T_J=25°C unless otherwise specified)

Symbol	Parameter	Test Condition	Min.	Typ.	Max.	Units
Off Characteristic						
V _{(BR)DSS}	Drain-Source Breakdown Voltage	V _{GS} =0V, I _D =250μA	20	-	-	V
I _{DSS}	Zero Gate Voltage Drain Current	V _{DS} =20V, V _{GS} =0V	-	-	1	μA
I _{GSS}	Gate to Body Leakage Current	V _{GS} = ±12V, V _{DS} =0V	-	-	±100	nA
On Characteristics						
V _{GS(th)}	Gate Threshold Voltage	V _{DS} =V _{GS} , I _D =250μA	0.4	0.7	1.0	V
R _{DS(on)}	Static Drain-Source On-Resistance <small>note3</small>	V _{GS} =4.5V, I _D =30A	-	2.7	3.5	mΩ
		V _{GS} =2.5V, I _D =20A	-	4	5.2	
Dynamic Characteristics						
C _{iss}	Input Capacitance	V _{DS} =10V, V _{GS} =0V, f=1.0MHz	-	3200	-	pF
C _{oss}	Output Capacitance		-	460	-	pF
C _{rss}	Reverse Transfer Capacitance		-	445	-	pF
Q _g	Total Gate Charge	V _{DS} =10V, I _D =30A, V _{GS} =4.5V	-	48	-	nC
Q _{gs}	Gate-Source Charge		-	3.6	-	nC
Q _{gd}	Gate-Drain("Miller") Charge		-	19	-	nC
Switching Characteristics						
t _{d(on)}	Turn-On Delay Time	V _{DS} =10V, I _D =30A, R _G =1.8Ω, V _{GS} =4.5V	-	9.7	-	ns
t _r	Turn-On Rise Time		-	37	-	ns
t _{d(off)}	Turn-Off Delay Time		-	63	-	ns
t _f	Turn-Off Fall Time		-	52	-	ns
Drain-Source Diode Characteristics and Maximum Ratings						
I _S	Maximum Continuous Drain to Source Diode Forward Current		-	-	90	A
I _{SM}	Maximum Pulsed Drain to Source Diode Forward Current		-	-	360	A
V _{SD}	Drain to Source Diode Forward Voltage	V _{GS} =0V, I _{SD} =30A, T _J =25°C	-	-	1.2	V
t _{rr}	Reverse Recovery Time	T _J =25°C, I _F =30A,	-	23	-	ns
Q _{rr}	Reverse Recovery Charge	di/dt =100A/μs	-	10	-	nC

Notes:1. Repetitive Rating: Pulse Width Limited by Maximum Junction Temperature

2. EAS condition: T_J=25°C, V_{DD}=15V, V_G=4.5V, R_G=25Ω, L=0.5mH, I_{AS}=21A

3. Pulse Test: Pulse Width≤300μs, Duty Cycle≤0.5%



CST90N02F Typical Performance Characteristics

Figure 1: Output Characteristics

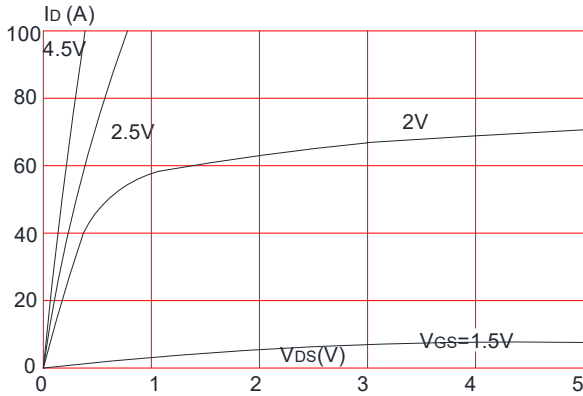

Figure 2: Typical Transfer Characteristics

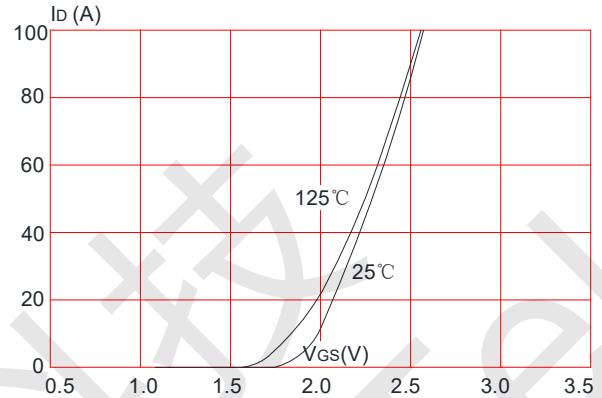

Figure 3: On-resistance vs. Drain Current

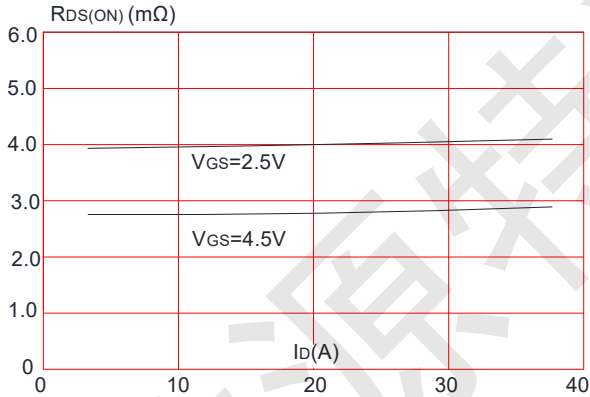

Figure 4: Body Diode Characteristics

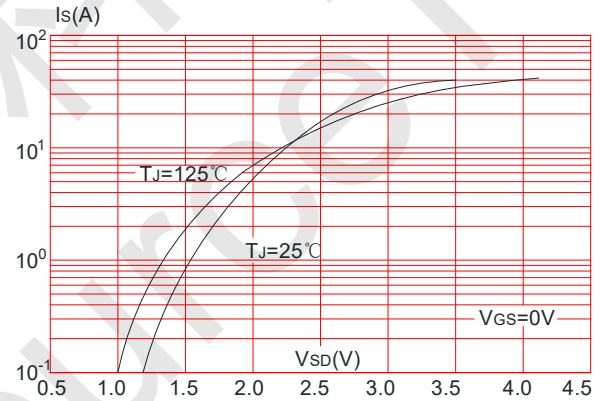

Figure 5: Gate Charge Characteristics

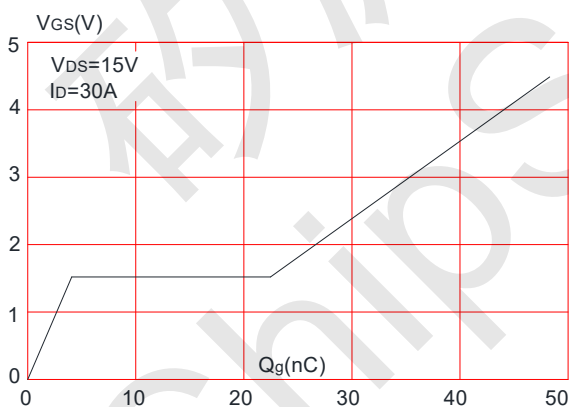
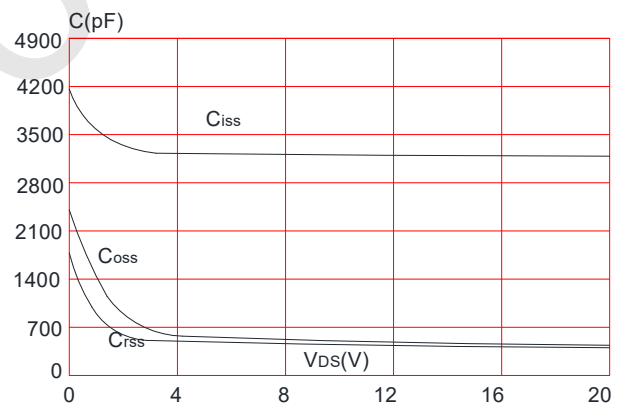

Figure 6: Capacitance Characteristics





CST90N02F N-Ch 20V Fast Switching MOSFETs

Figure 7: Normalized Breakdown Voltage vs. Junction Temperature

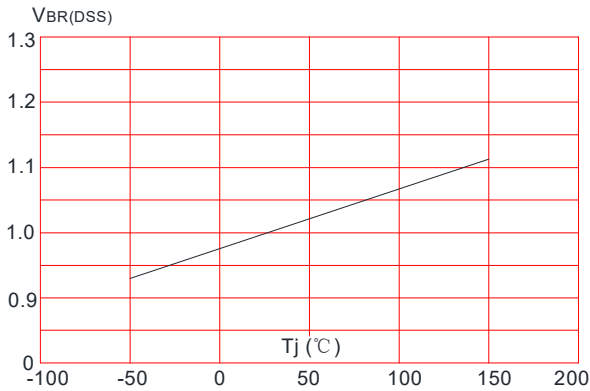

Figure 8: Normalized on Resistance vs. Junction Temperature

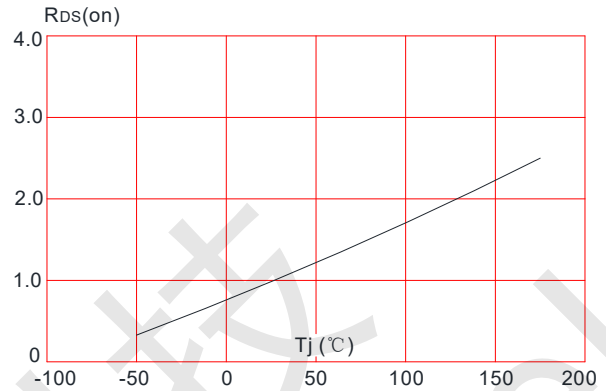

Figure 9: Maximum Safe Operating Area

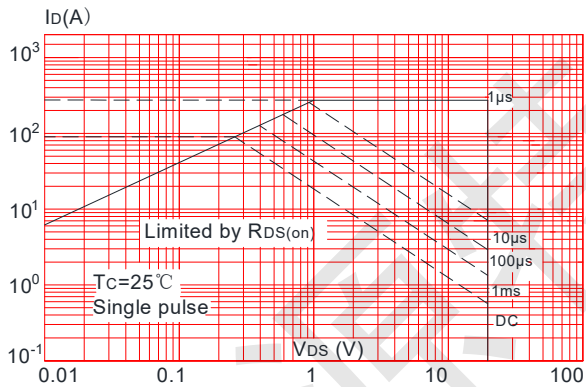

Figure 10: Maximum Continuous Drain Current vs. Case Temperature

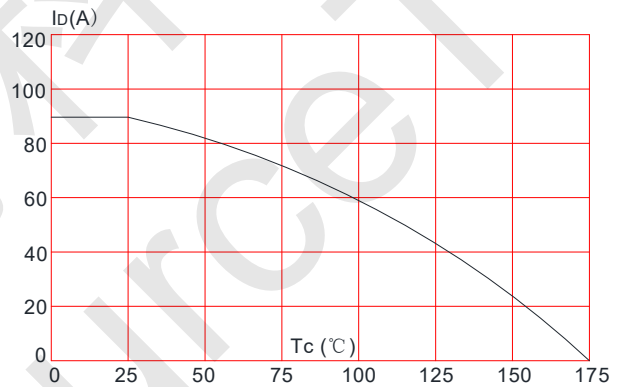
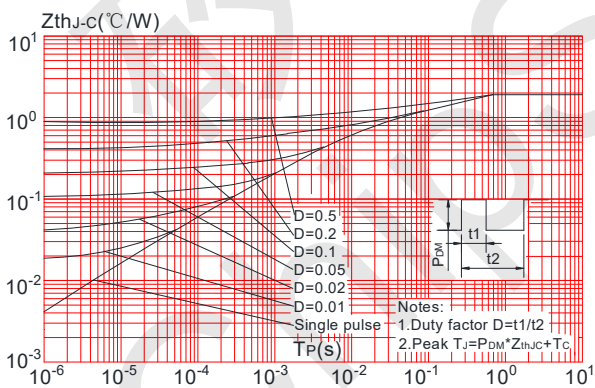
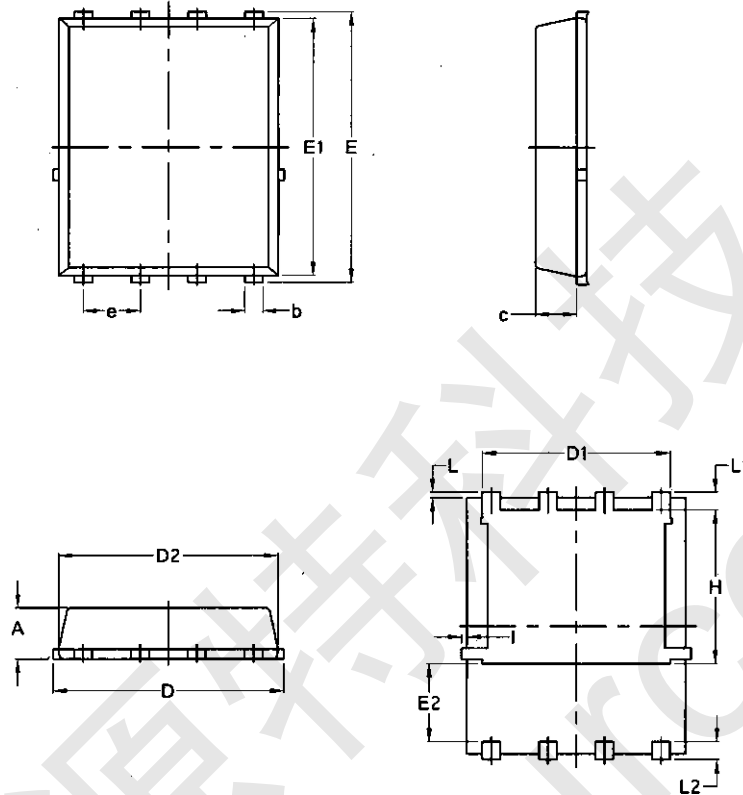

Figure.11: Maximum Effective Transient Thermal Impedance, Junction-to-Case





CST90N02F Package Mechanical Data-PDFN5060-8L-Single



Symbol	Common			
	mm		Inch	
	Min	Max	Min	Max
A	1.03	1.17	0.0406	0.0461
b	0.34	0.48	0.0134	0.0189
c	0.824	0.0970	0.0324	0.082
D	4.80	5.40	0.1890	0.2126
D1	4.11	4.31	0.1618	0.1697
D2	4.80	5.00	0.1890	0.1969
E	5.95	6.15	0.2343	0.2421
E1	5.65	5.85	0.2224	0.2303
E2	1.60	/	0.0630	/
e	1.27 BSC		0.05 BSC	
L	0.05	0.25	0.0020	0.0098
L1	0.38	0.50	0.0150	0.0197
L2	0.38	0.50	0.0150	0.0197
H	3.30	3.50	0.1299	0.1378
I	/	0.18	/	0.0070