



CST4606B N+P-Ch 20V Fast Switching MOSFETs

CST4606B Features

- Advanced high cell density Trench technology
- Super Low Gate Charge
- Excellent CdV/dt effect decline
- Green Device Available

CST4606B Applications

- Power management in half bridge and inverters
- DC-DC Converter
- Load Switch

CST4606B General Description

The CST4606B is the highest performance trench N-ch and P-ch MOSFETs with extreme high cell density, which provide excellent RDSON and gate charge for most of the synchronous buck converter applications.

The CST4606B meet the RoHS and Green Product requirement, 100% EAS guaranteed with full function reliability approved.

CST4606B Product Summary

BVDSS	RDSON	ID
20V	21mΩ	6A
-20V	52 mΩ	- 5A

CST4606B SOP-8 Pin Configuration

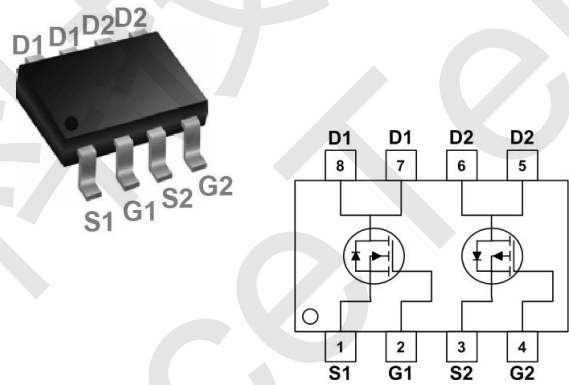

CST4606B Absolute Maximum Ratings

Symbol	Parameter	Rating		Units
		N-Channel	P-Channel	
V_{DS}	Drain-Source Voltage	20	-20	V
V_{GS}	Gate-Source Voltage	± 12	± 12	V
$I_D@T_C=25^\circ C$	Continuous Drain Current, $V_{GS} @ 10V^1$	6	-5	A
$I_D@T_C=100^\circ C$	Continuous Drain Current, $V_{GS} @ 10V^1$	5	-4	A
I_{DM}	Pulsed Drain Current ²	20	-12	A
EAS	Single Pulse Avalanche Energy ³	72	59	mJ
I_{AS}	Avalanche Current	21	-19	A
$P_D@T_C=25^\circ C$	Total Power Dissipation ⁴	2.5	2.08	W
T_{STG}	Storage Temperature Range	-55 to 150	-55 to 150	$^\circ C$
T_J	Operating Junction Temperature Range	-55 to 150	-55 to 150	$^\circ C$

CST4606B Thermal Data

Symbol	Parameter	Typ.	Max.	Unit
$R_{\theta JA}$	Thermal Resistance Junction-Ambient ¹	---	85	$^\circ C/W$
$R_{\theta JC}$	Thermal Resistance Junction-Case ¹	---	50	$^\circ C/W$



CST4606B Electrical Characteristics (T_J=25 °C unless otherwise specified)

Symbol	Parameter	Test Condition	Min.	Typ.	Max.	Units
Off Characteristic						
V _{(BR)DSS}	Drain-Source Breakdown Voltage	V _{GS} =0V, I _D =250μA	20	-	-	V
I _{DSS}	Zero Gate Voltage Drain Current	V _{DS} =20V, V _{GS} =0V,	-	-	1.0	μA
I _{GSS}	Gate to Body Leakage Current	V _{DS} =0V, V _{GS} =±12V	-	-	±100	nA
On Characteristics						
V _{GS(th)}	Gate Threshold Voltage	V _{DS} =V _{GS} , I _D =250μA	0.4	0.7	1	V
R _{DS(on)}	Static Drain-Source on-Resistance <small>note2</small>	V _{GS} =4.5V, I _D =4A	-	21	27	mΩ
		V _{GS} =2.5V, I _D =3A	-	29	44	
Dynamic Characteristics						
C _{iss}	Input Capacitance	V _{DS} =10V, V _{GS} =0V, f=1.0MHz	-	358	-	pF
C _{oss}	Output Capacitance		-	69.3	-	pF
C _{rss}	Reverse Transfer Capacitance		-	58.5	-	pF
Q _g	Total Gate Charge	V _{DS} =10V, I _D =2A, V _{GS} =4.5V	-	5.6	-	nC
Q _{gs}	Gate-Source Charge		-	0.8	-	nC
Q _{gd}	Gate-Drain("Miller") Charge		-	1	-	nC
Switching Characteristics						
t _{d(on)}	Turn-on Delay Time	V _{DS} =10V, I _D =4A, R _{GEN} =3Ω, V _{GS} =4.5V	-	5	-	ns
t _r	Turn-on Rise Time		-	30	-	ns
t _{d(off)}	Turn-off Delay Time		-	48	-	ns
t _f	Turn-off Fall Time		-	36	-	ns
Drain-Source Diode Characteristics and Maximum Ratings						
I _S	Maximum Continuous Drain to Source Diode Forward Current		-	-	4	A
I _{SM}	Maximum Pulsed Drain to Source Diode Forward Current		-	-	16	A
V _{SD}	Drain to Source Diode Forward Voltage	V _{GS} =0V, I _S =4A	-	-	1.2	V

Notes:1. Repetitive Rating: Pulse Width Limited by Maximum Junction Temperature

2. Pulse Test: Pulse Width≤300μs, Duty Cycle≤0.5%



CST4606B Electrical Characteristics (T_J=25 °C unless otherwise specified)

Symbol	Parameter	Test Condition	Min.	Typ.	Max.	Units
Off Characteristic						
V _{(BR)DSS}	Drain-Source Breakdown Voltage	V _{GS} =0V, I _D = -250μA	-20	-	-	V
I _{DSS}	Zero Gate Voltage Drain Current	V _{DS} = -20V, V _{GS} =0V,	-	-	-1	μA
I _{GSS}	Gate to Body Leakage Current	V _{DS} =0V, V _{GS} = ±12V	-	-	±100	nA
On Characteristics						
V _{GS(th)}	Gate Threshold Voltage	V _{DS} =V _{GS} , I _D = -250μA	-0.5	-0.7	-1.0	V
R _{DS(on)}	Static Drain-Source on-Resistance note2	V _{GS} = -4.5V, I _D = -3A	-	52	70	mΩ
		V _{GS} = -2.5V, I _D = -2A	-	70	100	
Dynamic Characteristics						
C _{iss}	Input Capacitance	V _{DS} = -10V, V _{GS} =0V, f=1.0MHz	-	503	-	pF
C _{oss}	Output Capacitance		-	67	-	pF
C _{rss}	Reverse Transfer Capacitance		-	58	-	pF
Q _g	Total Gate Charge	V _{DS} = -10V, I _D = -2A, V _{GS} = -4.5V	-	4.1	-	nC
Q _{gs}	Gate-Source Charge		-	0.8	-	nC
Q _{gd}	Gate-Drain("Miller") Charge		-	1.1	-	nC
Switching Characteristics						
t _{d(on)}	Turn-on Delay Time	V _{DD} = -10V, I _D = -3A, R _G =1Ω, V _{GEN} = -4.5V, R _L =1.2Ω	-	11	-	ns
t _r	Turn-on Rise Time		-	52	-	ns
t _{d(off)}	Turn-off Delay Time		-	16	-	ns
t _f	Turn-off Fall Time		-	10	-	ns
Drain-Source Diode Characteristics and Maximum Ratings						
I _S	Maximum Continuous Drain to Source Diode Forward Current		-	-	-3	A
I _{SM}	Maximum Pulsed Drain to Source Diode Forward Current		-	-	-12	A
V _{SD}	Drain to Source Diode Forward Voltage	V _{GS} =0V, I _S = -3A	-	-	-1.2	V

Notes:1. Repetitive Rating: Pulse Width Limited by Maximum Junction Temperature

2. Pulse Test: Pulse Width≤300μs, Duty Cycle≤2%



CST4606B Typical Performance Characteristics

P-Channel Typical Characteristics

Figure 1: Output Characteristics

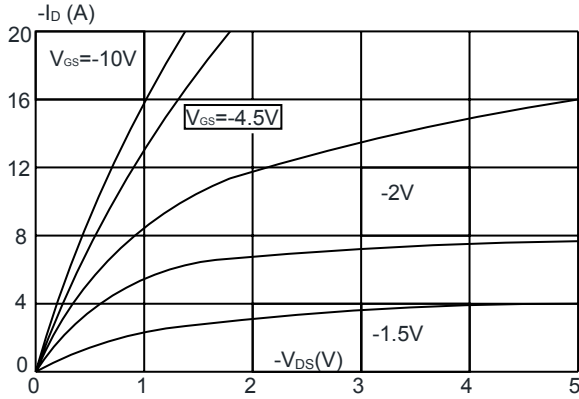

Figure 2: Typical Transfer Characteristics

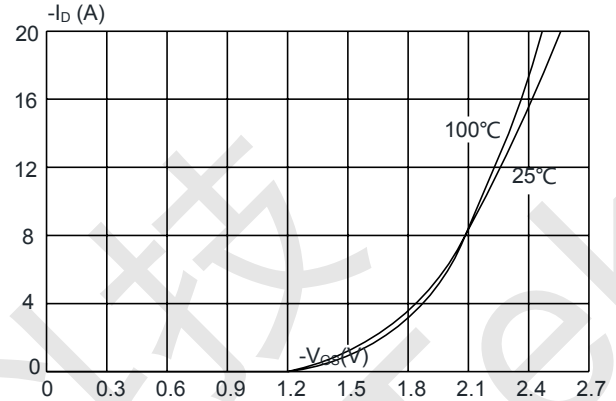

Figure 3: On-resistance vs. Drain Current

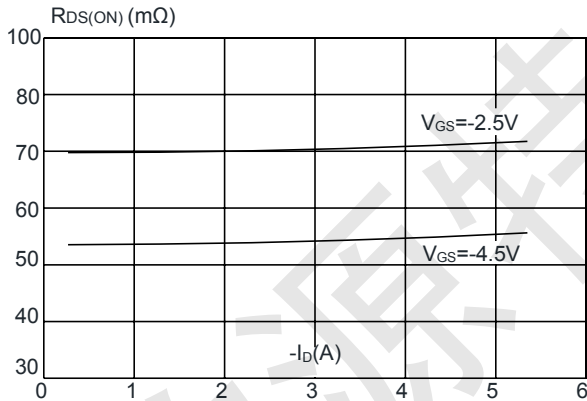

Figure 4: Body Diode Characteristics

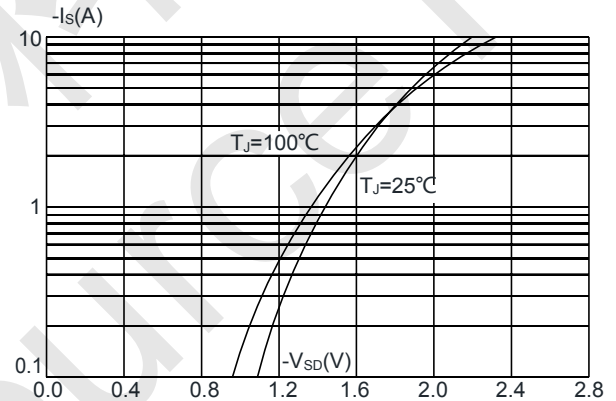

Figure 5: Gate Charge Characteristics

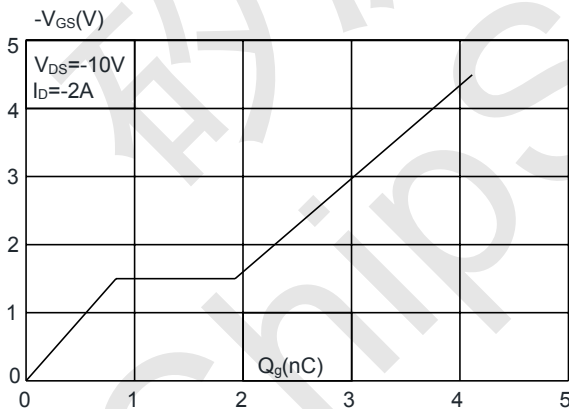
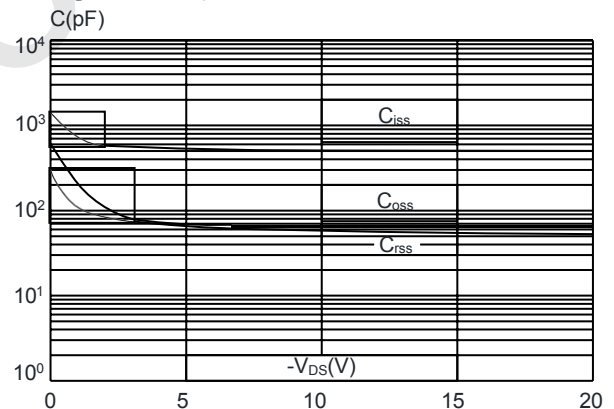

Figure 6: Capacitance Characteristics





CST4606B Typical Performance Characteristics

N-Channel Typical Characteristics

Figure 1: Output Characteristics

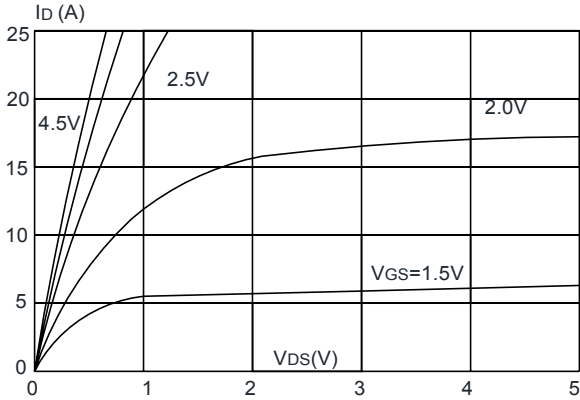

Figure 2: Typical Transfer Characteristics

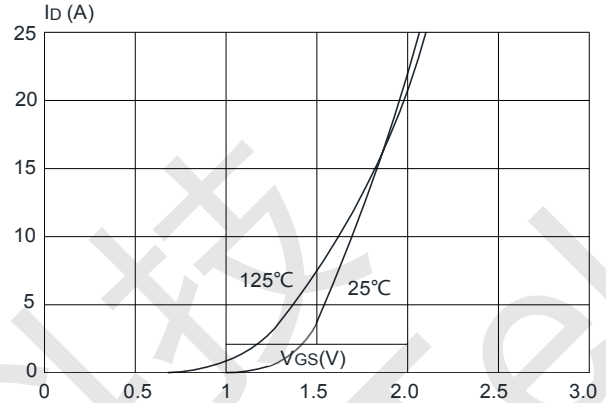

Figure 3: On-resistance vs. Drain Current

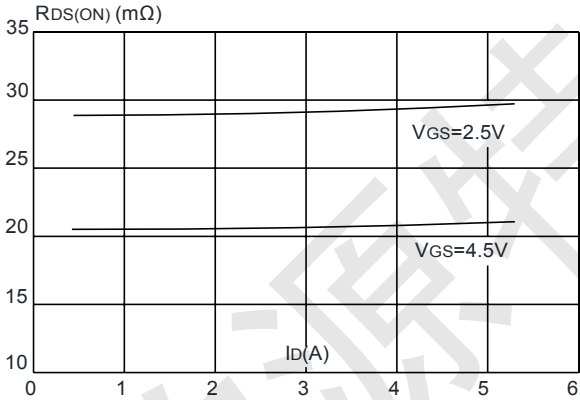

Figure 4: Body Diode Characteristics

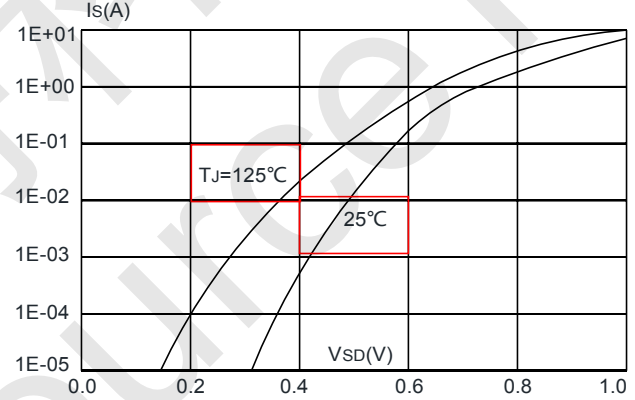

Figure 5: Gate Charge Characteristics

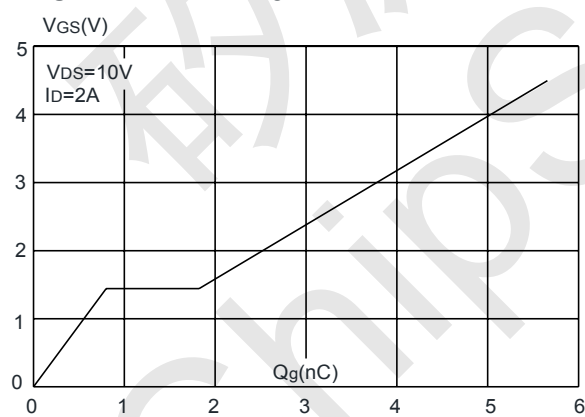
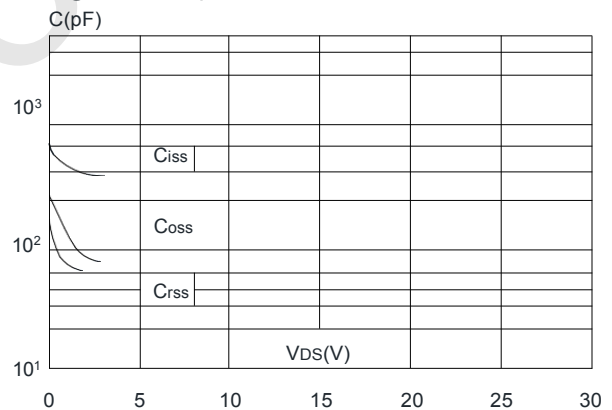
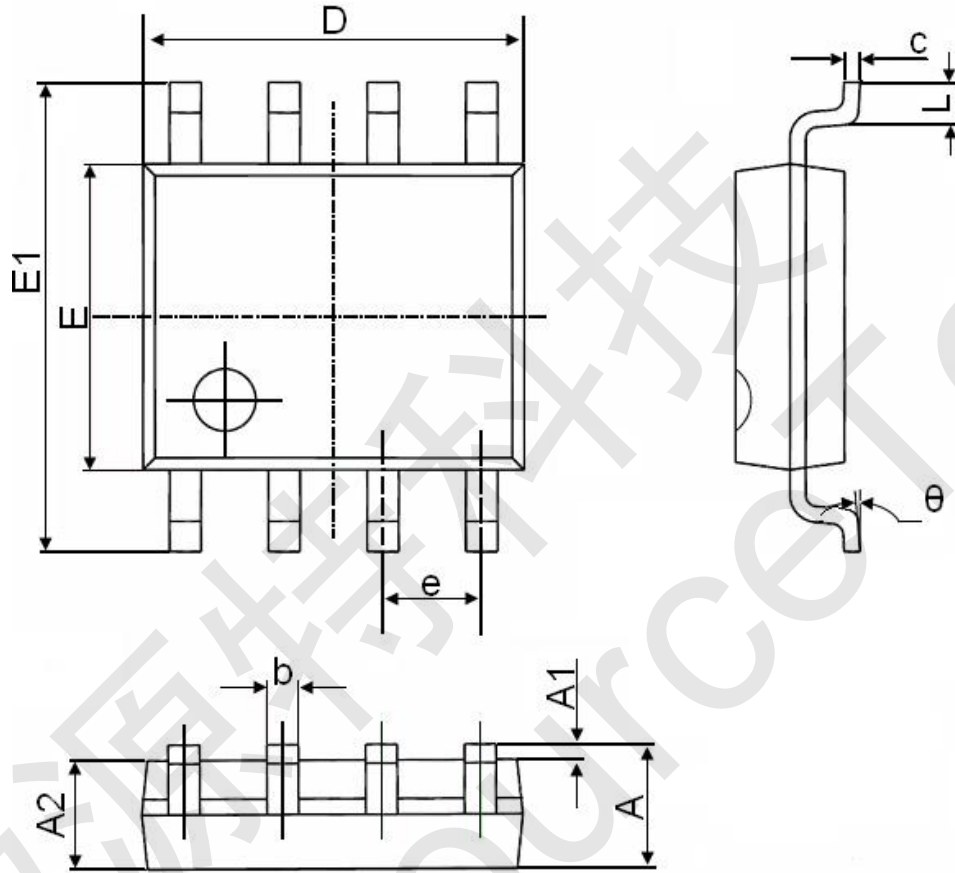

Figure 6: Capacitance Characteristics





CST4606B SOP-8 Package Information



Symbol	Dimensions In Millimeters		Dimensions In Inches	
	Min.	Max.	Min.	Max.
A	1.350	1.750	0.053	0.069
A1	0.100	0.250	0.004	0.010
A2	1.350	1.550	0.053	0.061
b	0.330	0.510	0.013	0.020
c	0.170	0.250	0.006	0.010
D	4.700	5.100	0.185	0.200
E	3.800	4.000	0.150	0.157
E1	5.800	6.200	0.228	0.244
e	1.270(BSC)		0.050(BSC)	
L	0.400	1.270	0.016	0.050
θ	0°	8°	0°	8°