



CST3415A P-Ch 20V Fast Switching MOSFETs

- ★ Super Low Gate Charge
- ★ Green Device Available
- ★ Excellent CdV/dt effect decline
- ★ Advanced high cell density Trench technology

CST3415A Product Summary



BVDSS	RDSON	ID
-20V	28mΩ	-5.0A

CST3415A Description

The CST3415A is the high cell density trenched P-ch MOSFETs, which provide excellent RDSON and gate charge for most of the synchronous buck converter applications.

The CST3415A meet the RoHS and Green Product requirement with full function reliability approved.

CST3415A SOT 23 Pin Configurations

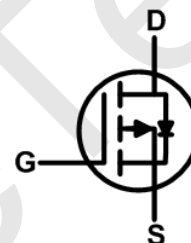
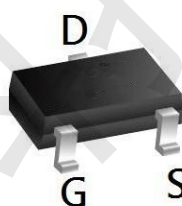

CST3415A Absolute Maximum Ratings

Symbol	Parameter	Rating	Units
V_{DS}	Drain-Source Voltage	-20	V
V_{GS}	Gate-Source Voltage	± 12	V
$I_D @ T_A = 25^\circ C$	Continuous Drain Current, $V_{GS} @ -4.5V^1$	-5.0	A
$I_D @ T_A = 70^\circ C$	Continuous Drain Current, $V_{GS} @ -4.5V^1$	-3.0	A
I_{DM}	Pulsed Drain Current ²	-16	A
$P_D @ T_A = 25^\circ C$	Total Power Dissipation ³	1.31	W
$P_D @ T_A = 70^\circ C$	Total Power Dissipation ³	0.84	W
T_{STG}	Storage Temperature Range	-55 to 150	$^\circ C$
T_J	Operating Junction Temperature Range	-55 to 150	$^\circ C$

CST3415A Thermal Data

Symbol	Parameter	Typ.	Max.	Unit
$R_{\theta JA}$	Thermal Resistance Junction-Ambient ¹	---	125	$^\circ C/W$
$R_{\theta JA}$	Thermal Resistance Junction-Ambient ¹ (t ≤ 10s)	---	---	$^\circ C/W$



CST3415A P-Ch 20V Fast Switching MOSFETs

CST3415A Electrical Characteristics (T_J=25°C unless otherwise specified)

Symbol	Parameter	Test Condition	Min.	Typ.	Max.	Units
Off Characteristic						
V _{(BR)DSS}	Drain-Source Breakdown Voltage	V _{GS} =0V, I _D = -250μA	-20	-	-	V
I _{DSS}	Zero Gate Voltage Drain Current	V _{DS} = -20V, V _{GS} =0V,	-	-	-1	μA
I _{GSS}	Gate to Body Leakage Current	V _{DS} =0V, V _{GS} = ±12V	-	-	±100	nA
On Characteristics						
V _{GS(th)}	Gate Threshold Voltage	V _{DS} =V _{GS} , I _D = -250μA	-0.4	-0.7	-1.0	V
R _{DS(on)}	Static Drain-Source on-Resistance <small>note2</small>	V _{GS} = -4.5V, I _D = -4.1A	-	28	35	mΩ
		V _{GS} = -2.5V, I _D = -3A	-	38	53	
Dynamic Characteristics						
C _{iss}	Input Capacitance	V _{DS} = -10V, V _{GS} =0V, f=1.0MHz	-	830	-	pF
C _{oss}	Output Capacitance		-	132	-	pF
C _{rss}	Reverse Transfer Capacitance		-	85	-	pF
Q _g	Total Gate Charge	V _{DS} = -10V, I _D = -2A, V _{GS} = -4.5V	-	8.8	-	nC
Q _{gs}	Gate-Source Charge		-	1.4	-	nC
Q _{gd}	Gate-Drain("Miller") Charge		-	1.9	-	nC
Switching Characteristics						
t _{d(on)}	Turn-on Delay Time	V _{DD} = -10V, I _D = -3.3A, R _G = 1Ω, V _{GEN} = -4.5V	-	10	-	ns
t _r	Turn-on Rise Time		-	32	-	ns
t _{d(off)}	Turn-off Delay Time		-	50	-	ns
t _f	Turn-off Fall Time		-	51	-	ns
Drain-Source Diode Characteristics and Maximum Ratings						
I _S	Maximum Continuous Drain to Source Diode Forward Current		-	-	-5.0	A
I _{SM}	Maximum Pulsed Drain to Source Diode Forward Current		-	-	-16	A
V _{SD}	Drain to Source Diode Forward Voltage	V _{GS} =0V, I _S = -4.1A	-	-	-1.2	V

Notes:1. Repetitive Rating: Pulse Width Limited by Maximum Junction Temperature

2. Pulse Test: Pulse Width≤300μs, Duty Cycle≤2%



CST3415A Typical Performance Characteristics

Figure 1: Output Characteristics

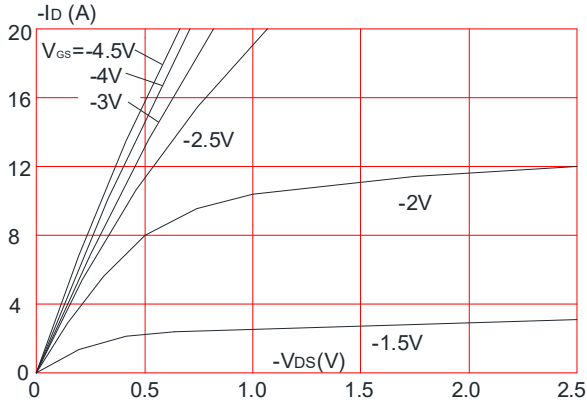

Figure 2: Typical Transfer Characteristics

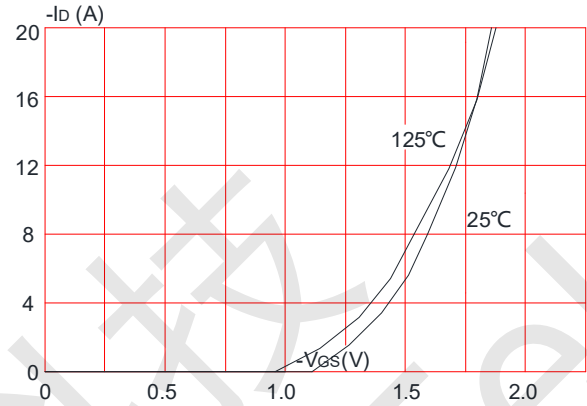

Figure 3: On-resistance vs. Drain Current

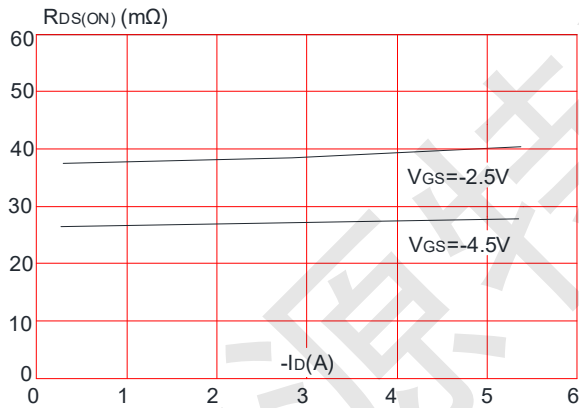

Figure 4: Body Diode Characteristics

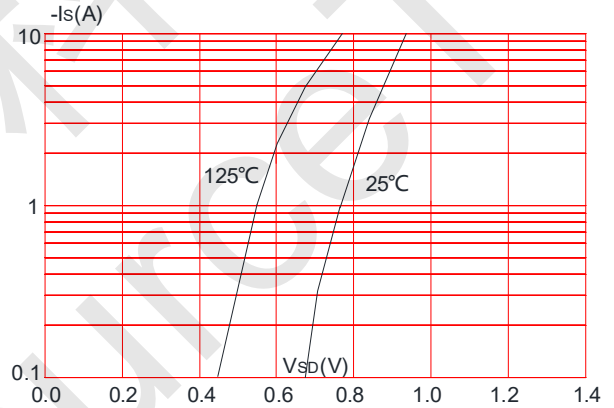

Figure 5: Gate Charge Characteristics

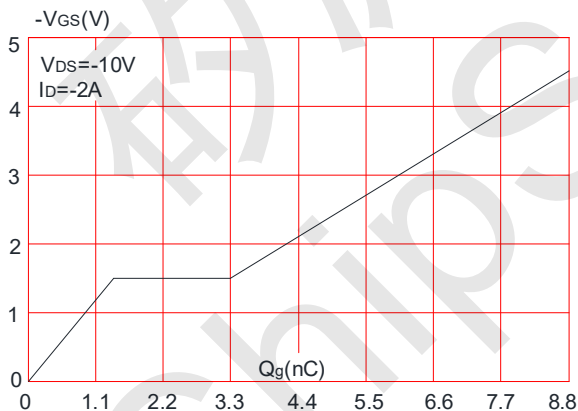
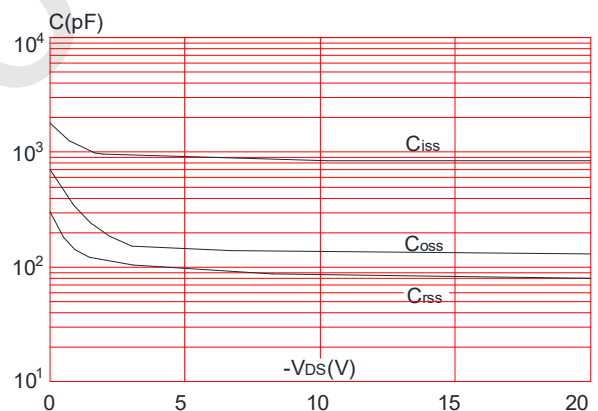

Figure 6: Capacitance Characteristics





CST3415A P-Ch 20V Fast Switching MOSFETs

Figure 7: Normalized Breakdown Voltage vs. Junction Temperature

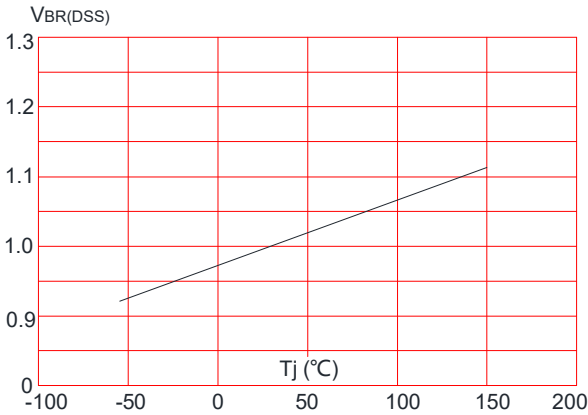

Figure 8: Normalized on Resistance vs. Junction Temperature

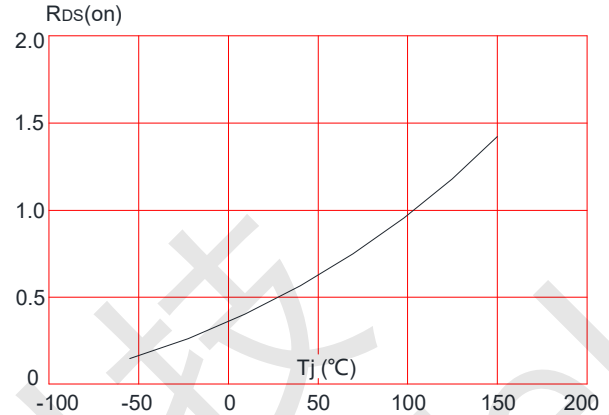

Figure 9: Maximum Safe Operating Area

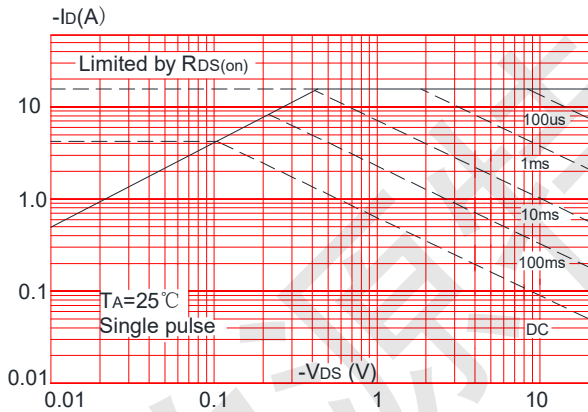

Figure 10: Maximum Continuous Drain Current vs. Ambient Temperature

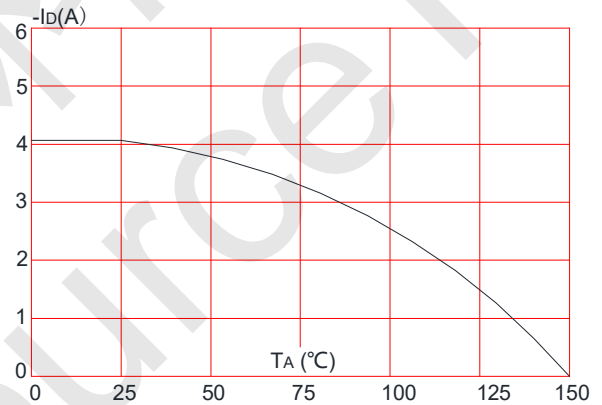
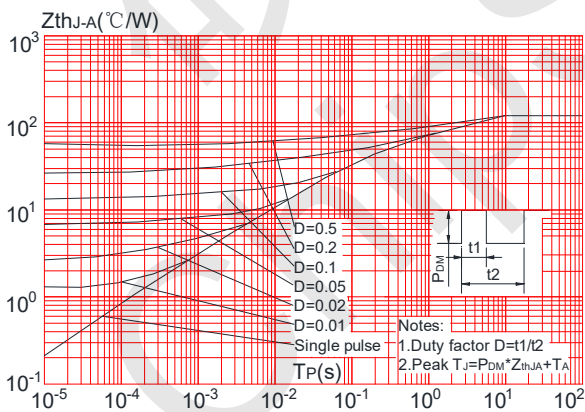
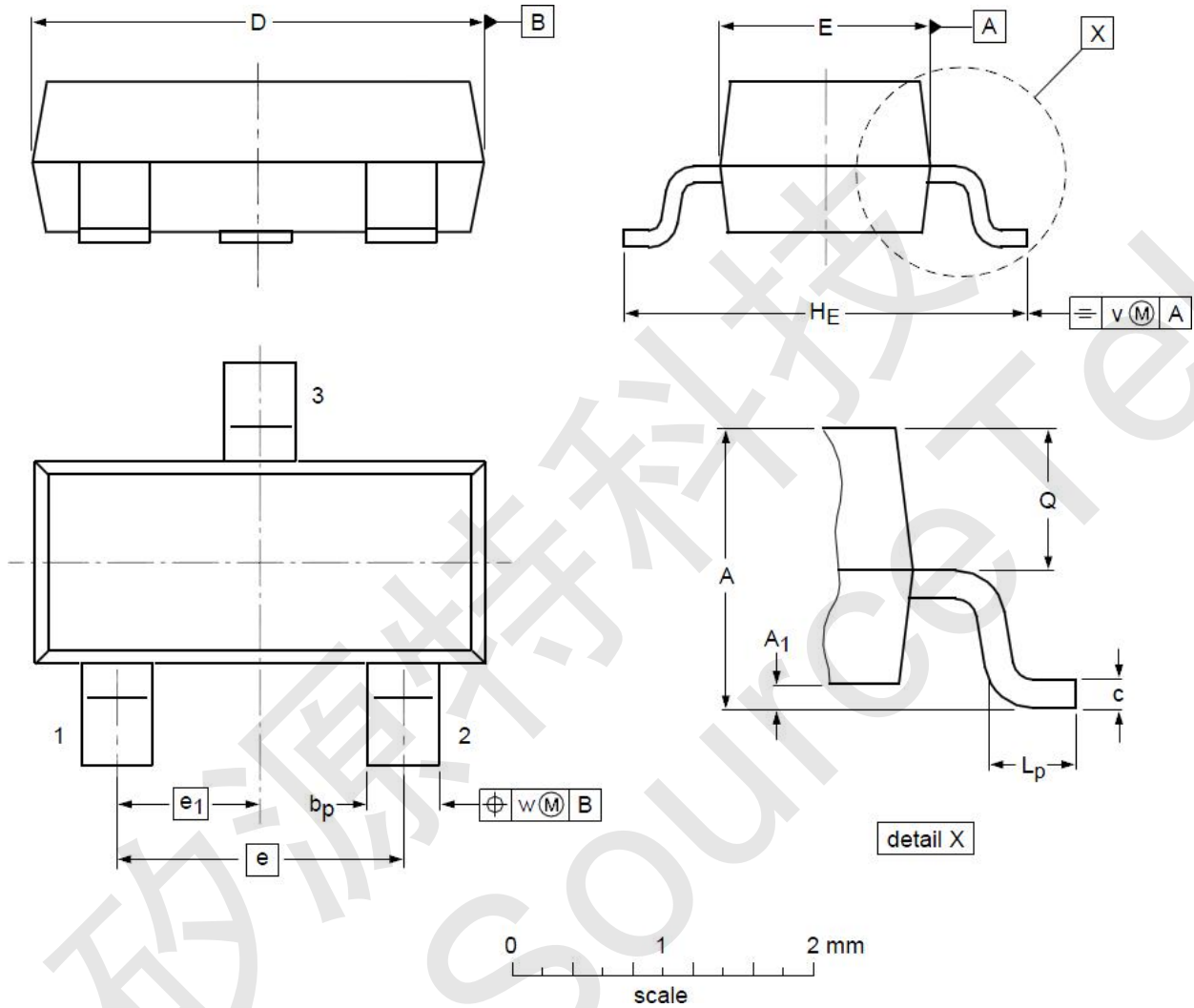

Figure.11: Maximum Effective Transient Thermal Impedance, Junction-to-Ambient





CST3415A Package Mechanical Data-SOT-23



DIMENSIONS (unit : mm)

Symbol	Min	Typ	Max	Symbol	Min	Typ	Max
A	0.90	1.01	1.15	A ₁	0.01	0.05	0.10
b _p	0.30	0.42	0.50	c	0.08	0.13	0.15
D	2.80	2.92	3.00	E	1.20	1.33	1.40
e	--	1.90	--	e ₁	--	0.95	--
H _E	2.25	2.40	2.55	L _p	0.30	0.42	0.50
Q	0.45	0.49	0.55	v	--	0.20	--
w	--	0.10	--				