



### CST30P06BL P-Ch 30V Fast Switching MOSFETs

- ★ Green Device Available
- ★ Super Low Gate Charge
- ★ Excellent CdV/dt effect decline
- ★ Advanced high cell density Trench technology

#### CST30P06BL Product Summary



BVDSS	RDSON	ID
-30V	28mΩ	-6.0A

#### CST30P06BL Description

The CST30P06BL is the high cell density trenched P-ch MOSFETs, which provides excellent RDSON and efficiency for most of the small power switching and load switch applications.

The CST30P06BL meet the RoHS and Green Product requirement with full function reliability approved.

#### CST30P06BL SOT23 Pin Configuration

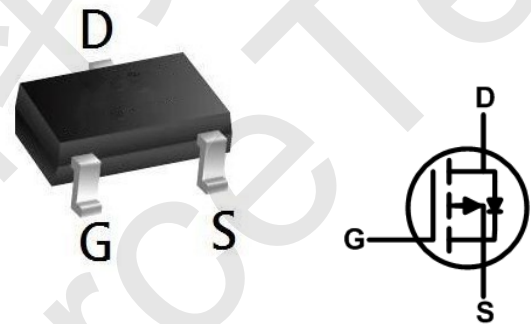

#### CST30P06BL Absolute Maximum Ratings (T<sub>A</sub>=25°C unless otherwise specified)

Symbol	Parameter	Max.	Units	
V <sub>DSS</sub>	Drain-Source Voltage	-30	V	
V <sub>GSS</sub>	Gate-Source Voltage	±20	V	
I <sub>D</sub>	Continuous Drain Current	T <sub>A</sub> = 25°C	-6	A
		T <sub>A</sub> = 100°C	-4.6	A
I <sub>DM</sub>	Pulsed Drain Current <sup>note1</sup>	-18	A	
P <sub>D</sub>	Power Dissipation	1.5	W	
R <sub>θJA</sub>	Thermal Resistance, Junction to Ambient	61.7	°C/W	
T <sub>J</sub> , T <sub>STG</sub>	Operating and Storage Temperature Range	-55 to +150	°C	



### CST30P06BL P-Ch 30V Fast Switching MOSFETs

#### CST30P06BL Electrical Characteristics (T<sub>J</sub>=25°C unless otherwise specified)

Symbol	Parameter	Test Condition	Min.	Typ.	Max.	Units
<b>Off Characteristic</b>						
V <sub>(BR)DSS</sub>	Drain-Source Breakdown Voltage	V <sub>GS</sub> =0V, I <sub>D</sub> = -250μA	-30	-	-	V
I <sub>DSS</sub>	Zero Gate Voltage Drain Current	V <sub>DS</sub> = -30V, V <sub>GS</sub> =0V,	-	-	-1	μA
I <sub>GSS</sub>	Gate to Body Leakage Current	V <sub>DS</sub> =0V, V <sub>GS</sub> = ±20V	-	-	±100	nA
<b>On Characteristics</b>						
V <sub>GS(th)</sub>	Gate Threshold Voltage	V <sub>DS</sub> =V <sub>GS</sub> , I <sub>D</sub> = -250μA	-0.7	-1.1	-1.5	V
R <sub>DS(on)</sub>	Static Drain-Source on-Resistance <small>note3</small>	V <sub>GS</sub> = -10V, I <sub>D</sub> = -5A	-	28	32	mΩ
		V <sub>GS</sub> = -4.5V, I <sub>D</sub> = -4A	-	34	42	
<b>Dynamic Characteristics</b>						
C <sub>iss</sub>	Input Capacitance	V <sub>DS</sub> = -15V, V <sub>GS</sub> =0V, f=1.0MHz	-	982	-	pF
C <sub>oss</sub>	Output Capacitance		-	135	-	pF
C <sub>rss</sub>	Reverse Transfer Capacitance		-	109	-	pF
Q <sub>g</sub>	Total Gate Charge	V <sub>DS</sub> = -15V, I <sub>D</sub> = -4A, V <sub>GS</sub> = -10V	-	10	-	nC
Q <sub>gs</sub>	Gate-Source Charge		-	2	-	nC
Q <sub>gd</sub>	Gate-Drain("Miller") Charge		-	2.7	-	nC
<b>Switching Characteristics</b>						
t <sub>d(on)</sub>	Turn-on Delay Time	V <sub>DD</sub> = -15V, I <sub>D</sub> = -7A, V <sub>GS</sub> = -10V, R <sub>GEN</sub> =2.5Ω	-	11	-	ns
t <sub>r</sub>	Turn-on Rise Time		-	19	-	ns
t <sub>d(off)</sub>	Turn-off Delay Time		-	45	-	ns
t <sub>f</sub>	Turn-off Fall Time		-	26	-	ns
<b>Drain-Source Diode Characteristics and Maximum Ratings</b>						
I <sub>S</sub>	Maximum Continuous Drain to Source Diode Forward Current		-	-	-6	A
I <sub>SM</sub>	Maximum Pulsed Drain to Source Diode Forward Current		-	-	-28	A
V <sub>SD</sub>	Drain to Source Diode Forward Voltage	V <sub>GS</sub> =0V, I <sub>S</sub> = -7A	-	-0.8	-1.2	V

Notes:1. Repetitive Rating: Pulse Width Limited by Maximum Junction Temperature

2. Pulse Test: Pulse Width≤300μs, Duty Cycle≤2%



## CST30P06BL Typical Performance Characteristics

Figure 1: Output Characteristics

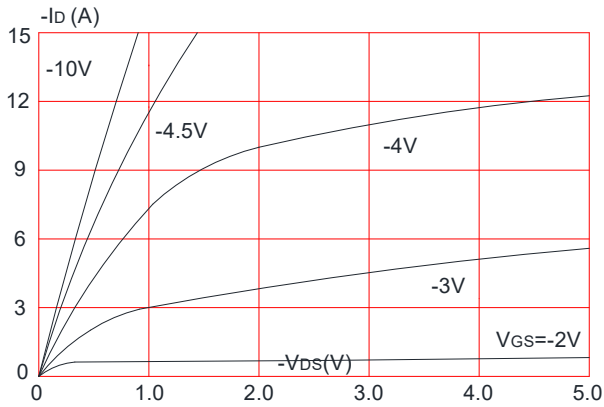

Figure 2: Typical Transfer Characteristics

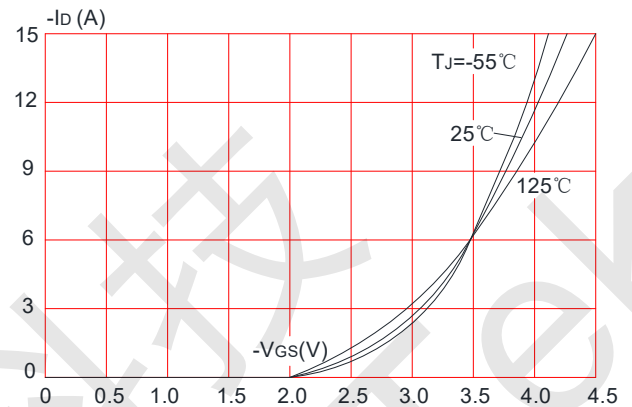

Figure 3: On-resistance vs. Drain Current

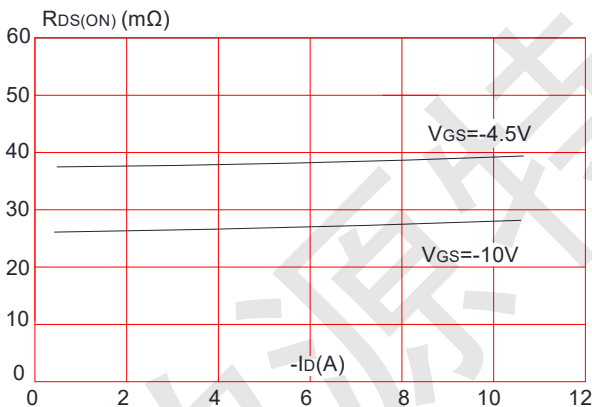

Figure 4: Body Diode Characteristics

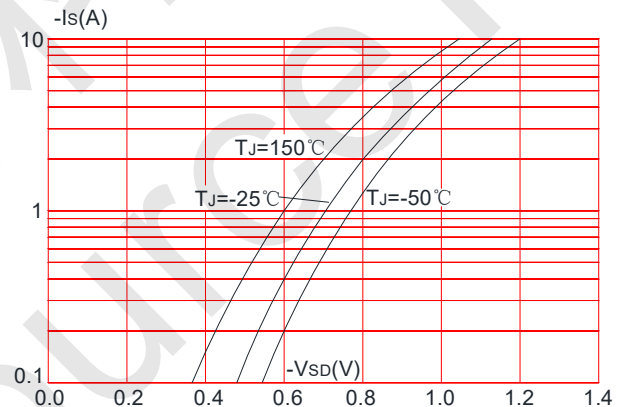

Figure 5: Gate Charge Characteristics

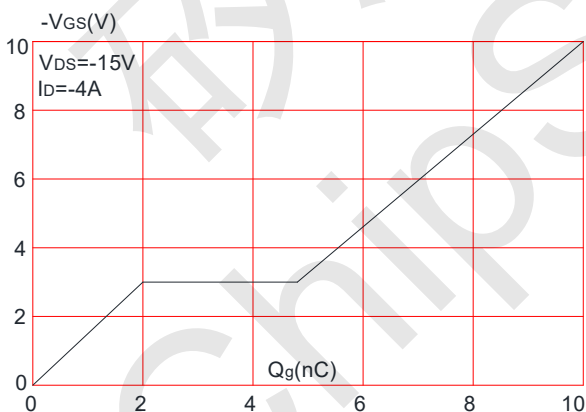
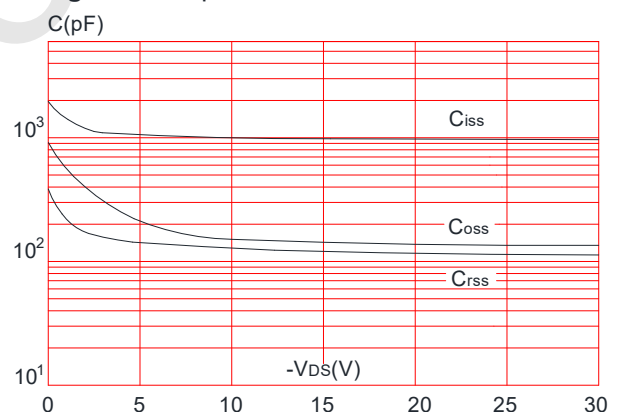

Figure 6: Capacitance Characteristics





### CST30P06BL P-Ch 30V Fast Switching MOSFETs

**Figure 7:** Normalized Breakdown Voltage vs. Junction Temperature

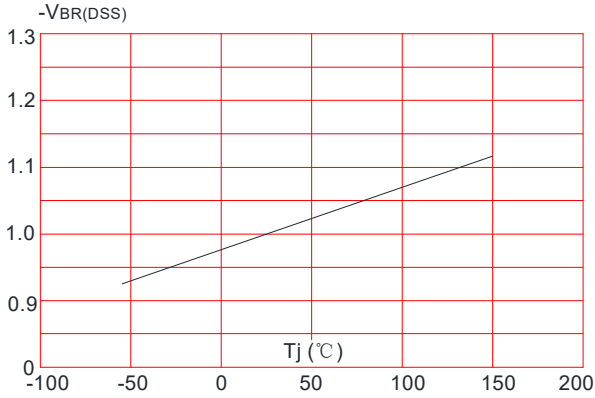

**Figure 8:** Normalized on Resistance vs. Junction Temperature

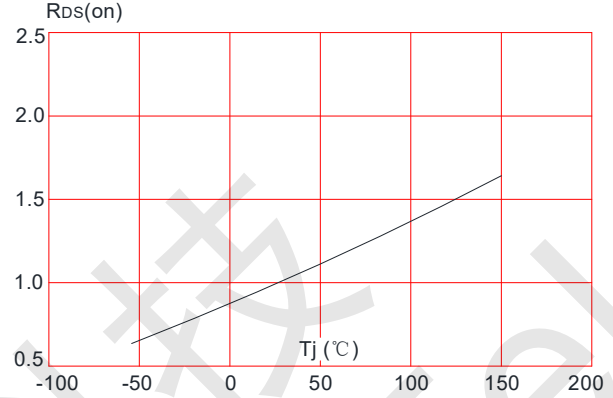

**Figure 9:** Maximum Safe Operating Area

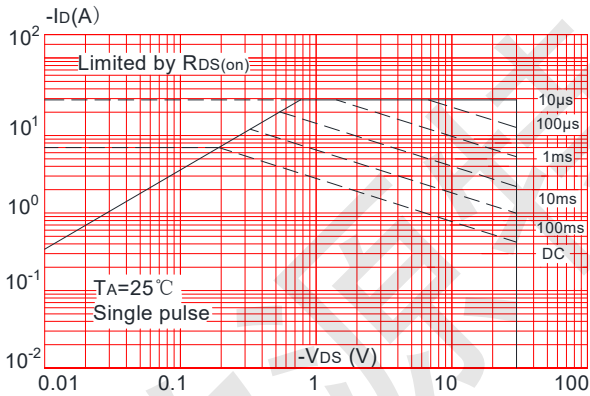

**Figure 10:** Maximum Continuous Drain Current vs. Ambient Temperature

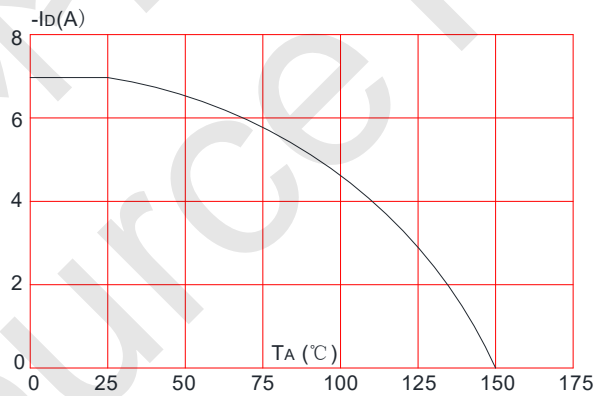

Maximum Effective Transient Thermal Impedance, Junction-to-Ambient

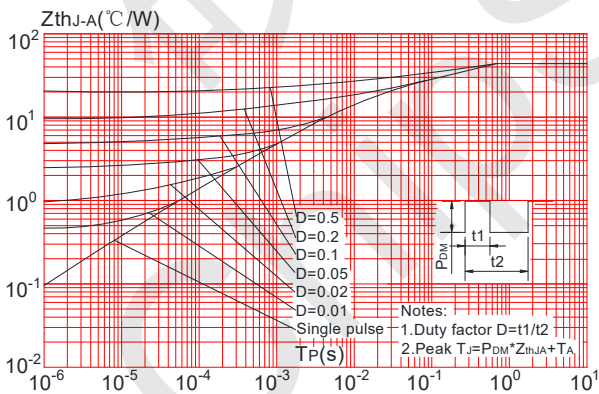



CST30P06BL Package Mechanical Data-SOT-23

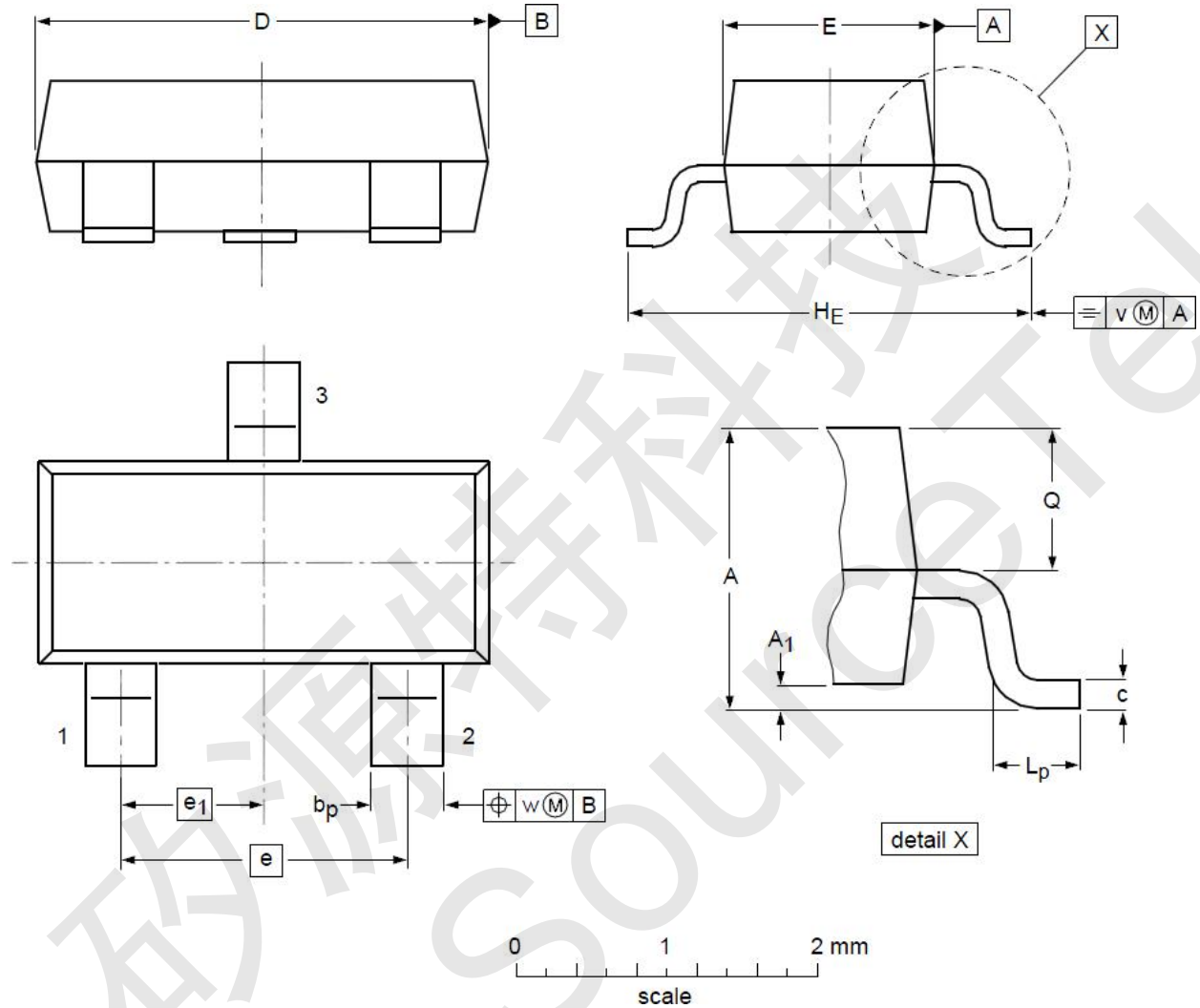

DIMENSIONS ( unit : mm )

Symbol	Min	Typ	Max	Symbol	Min	Typ	Max
A	0.90	1.01	1.15	A <sub>1</sub>	0.01	0.05	0.10
b <sub>p</sub>	0.30	0.42	0.50	c	0.08	0.13	0.15
D	2.80	2.92	3.00	E	1.20	1.33	1.40
e	--	1.90	--	e <sub>1</sub>	--	0.95	--
H <sub>E</sub>	2.25	2.40	2.55	L <sub>p</sub>	0.30	0.42	0.50
Q	0.45	0.49	0.55	v	--	0.20	--
w	--	0.10	--				