



CST20P10 P-Ch 100V Fast Switching MOSFETs

- ★ Super Low Gate Charge
- ★ 100% EAS Guaranteed
- ★ Green Device Available
- ★ Excellent CdV/dt effect decline
- ★ Advanced high cell density Trench technology

CST20P10 Product Summary



BVDSS	RDSON	ID
-100V	80mΩ	-20A

CST20P10 Description

The CST20P10 is the high cell density trenched P-ch MOSFETs, which provide excellent RDSON and gate charge for most of the synchronous buck converter applications.

The CST20P10 meet the RoHS and Green Product requirement, 100% EAS guaranteed with full function reliability approved.

CST20P10 TO252 Pin Configuration

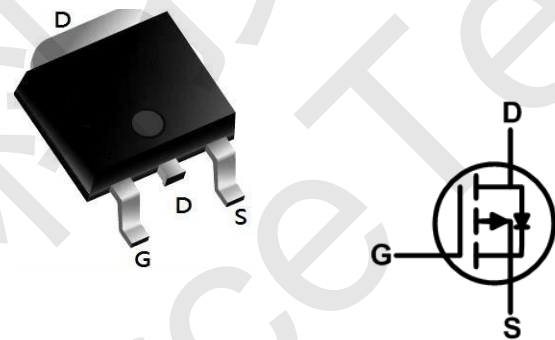

CST20P10 Absolute Maximum Ratings (T_A = 25°C, unless otherwise noted)

Parameter	Symbol	Value	Unit
Drain-Source Voltage	V _{DS}	-100	V
Gate-Source Voltage	V _{GS}	±20	V
Continuous Drain Current	I _D	T _C = 25°C	-20
		T _C = 100°C	-11
Pulsed Drain Current ¹	I _{DM}	-72	A
Single Pulse Avalanche Energy ²	EAS	132.25	mJ
Total Power Dissipation	P _D	70	W
Operating Junction and Storage Temperature Range	T _J , T _{STG}	-55 to 150	°C

CST20P10 Thermal Characteristics

Parameter	Symbol	Value	Unit
Thermal Resistance from Junction-to-Ambient ³	R _{θJA}	75	°C/W
Thermal Resistance from Junction-to-Case	R _{θJC}	1.78	°C/W



CST20P10 P-Ch 100V Fast Switching MOSFETs

CST20P10 Electrical Characteristics (T_J = 25°C, unless otherwise)

Parameter	Symbol	Test Conditions	Min.	Typ.	Max.	Unit	
Static Characteristics							
Drain-Source Breakdown Voltage	V _{(BR)DSS}	V _{GS} = 0V, I _D = -250μA	-100	-	-	V	
Gate-body Leakage current	I _{GSS}	V _{DS} = 0V, V _{GS} = ±20V	-	-	±100	nA	
Zero Gate Voltage Drain Current	I _{DSS}	V _{DS} = -100V, V _{GS} = 0V	T _J = 25°C	-	-	-1	μA
			T _J = 100°C	-	-	-100	
Gate-Threshold Voltage	V _{GS(th)}	V _{DS} = V _{GS} , I _D = -250μA	-1	-1.8	-2.5	V	
Drain-Source On-Resistance ⁴	R _{DS(on)}	V _{GS} = -10V, I _D = -10A	-	80	100	mΩ	
		V _{GS} = -4.5V, I _D = -6A	-	88	120		
Forward Transconductance ⁴	g _{fs}	V _{DS} = -10V, I _D = -10A	-	30	-	S	
Dynamic Characteristics⁵							
Input Capacitance	C _{iss}	V _{DS} = -50V, V _{GS} = 0V, f = 1MHz	-	3985	-	pF	
Output Capacitance	C _{oss}		-	85	-		
Reverse Transfer Capacitance	C _{rss}		-	71	-		
Gate Resistance	R _g	f = 1MHz	-	4	-	Ω	
Switching Characteristics⁵							
Total Gate Charge	Q _g	V _{GS} = -10V, V _{DS} = -50V, I _D = -10A	-	65	-	nC	
Gate-Source Charge	Q _{gs}		-	10.2	-		
Gate-Drain Charge	Q _{gd}		-	13	-		
Turn-On Delay Time	t _{d(on)}	V _{GS} = -10V, V _{DD} = -50V, R _G = 3Ω, I _D = -10A	-	12.8	-	ns	
Rise Time	t _r		-	30	-		
Turn-Off Delay Time	t _{d(off)}		-	82	-		
Fall Time	t _f		-	61	-		
Body Diode Reverse Recovery Time	t _{rr}	I _F = -10A, dI/dt = 100A/μs	-	62	-	ns	
Body Diode Reverse Recovery Charge	Q _{rr}		-	56	-	nC	
Drain-Source Body Diode Characteristics							
Diode Forward Voltage ⁴	V _{SD}	I _S = -10A, V _{GS} = 0V	-	-	-1.2	V	
Continuous Source Current	I _S	T _C = 25°C	-	-	-20	A	

Notes:

1. Repetitive rating, pulse width limited by junction temperature T_{J(MAX)} = 150°C.
2. The EAS data shows Max. rating . The test condition is V_{DD} = -35V, V_{GS} = -10V, L = 0.5mH, I_{AS} = -23A
3. The data tested by surface mounted on a 1 inch² FR-4 board with 2OZ copper, The value in any given application depends on the user's specific board design.
4. The data tested by pulsed , pulse width ≤ 300us , duty cycle ≤ 2%.
5. This value is guaranteed by design hence it is not included in the production test..



CST20P10 Typical Characteristics

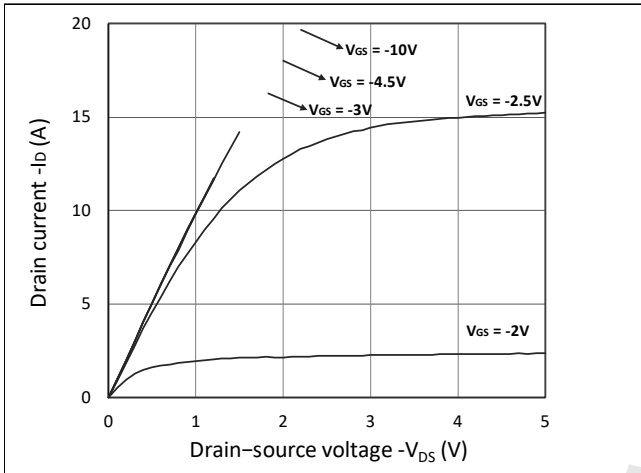

Figure 1. Output Characteristics

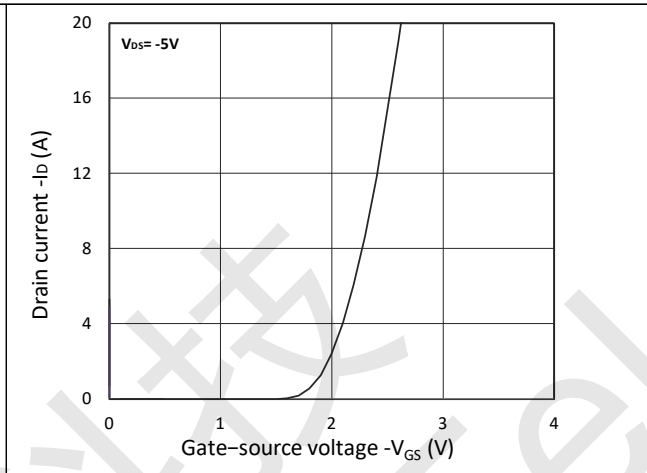

Figure 2. Transfer Characteristics

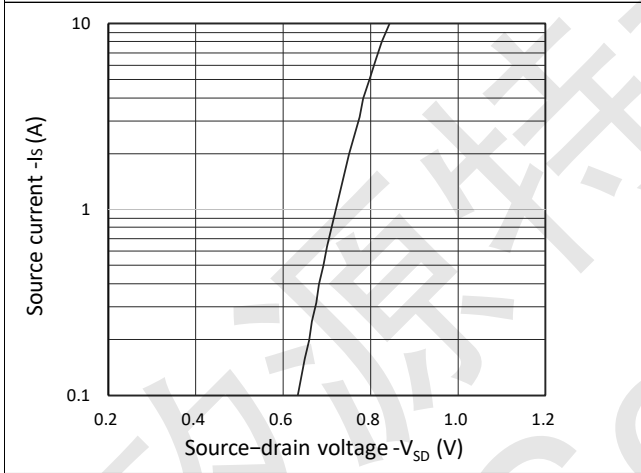

Figure 3. Forward Characteristics of Reverse

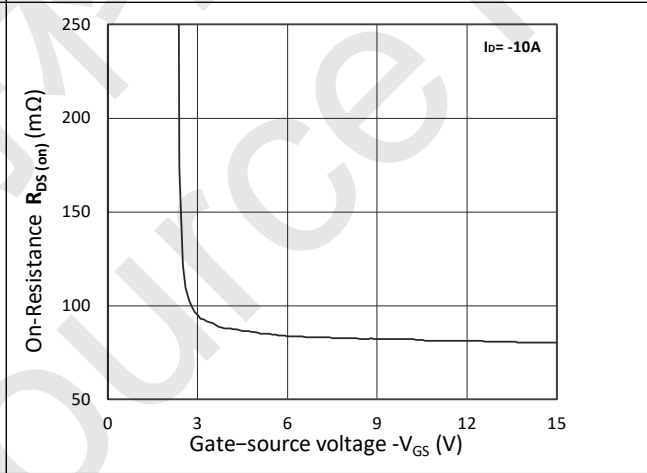

Figure 4. $R_{DS(ON)}$ vs. V_{GS}

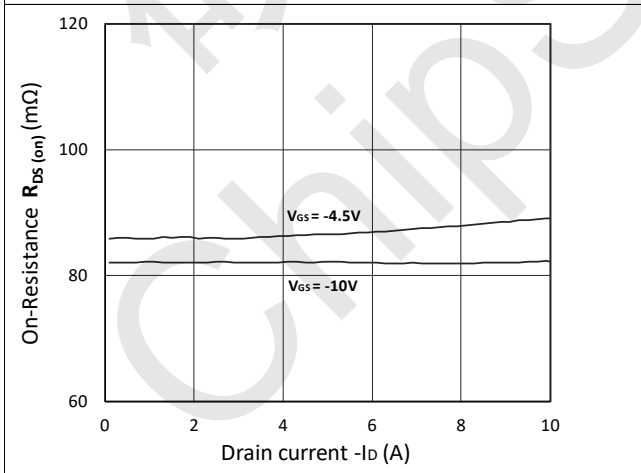

Figure 5. $R_{DS(ON)}$ vs. I_D

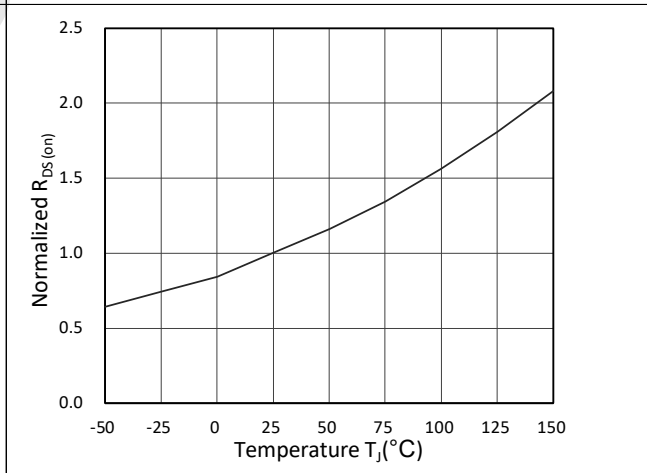

Figure 6. Normalized $R_{DS(on)}$ vs. Temperature



CST20P10 P-Ch 100V Fast Switching MOSFETs

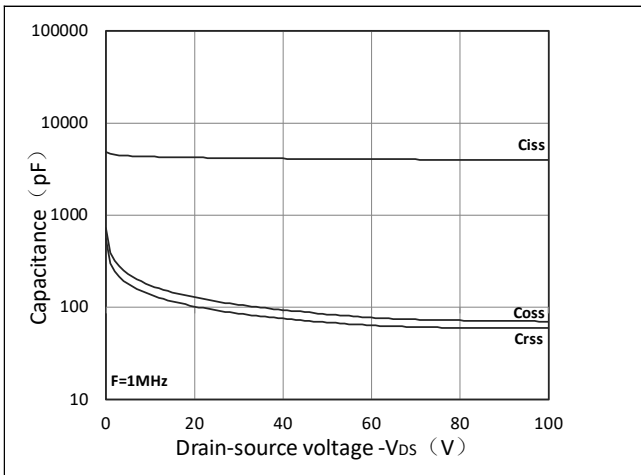

Figure 7. Capacitance Characteristics

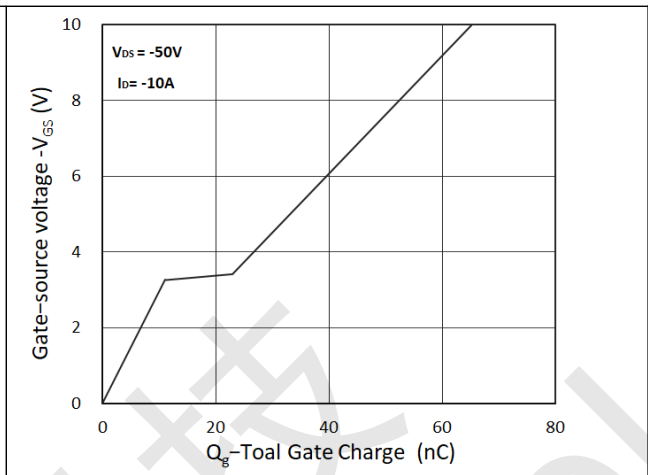

Figure 8. Gate Charge Characteristics

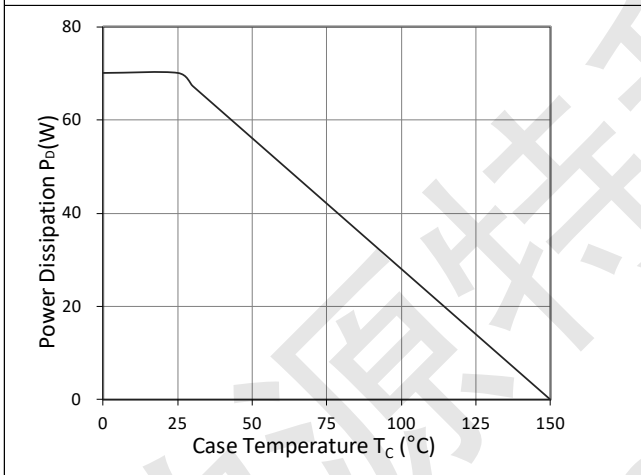

Figure 9. Power Dissipation

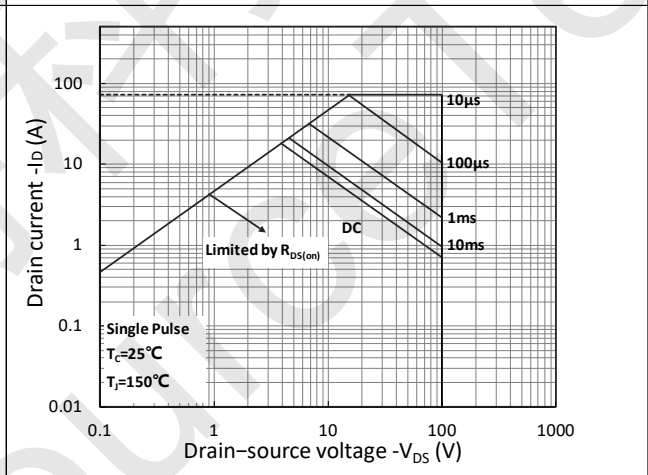

Figure 10. Safe Operating Area

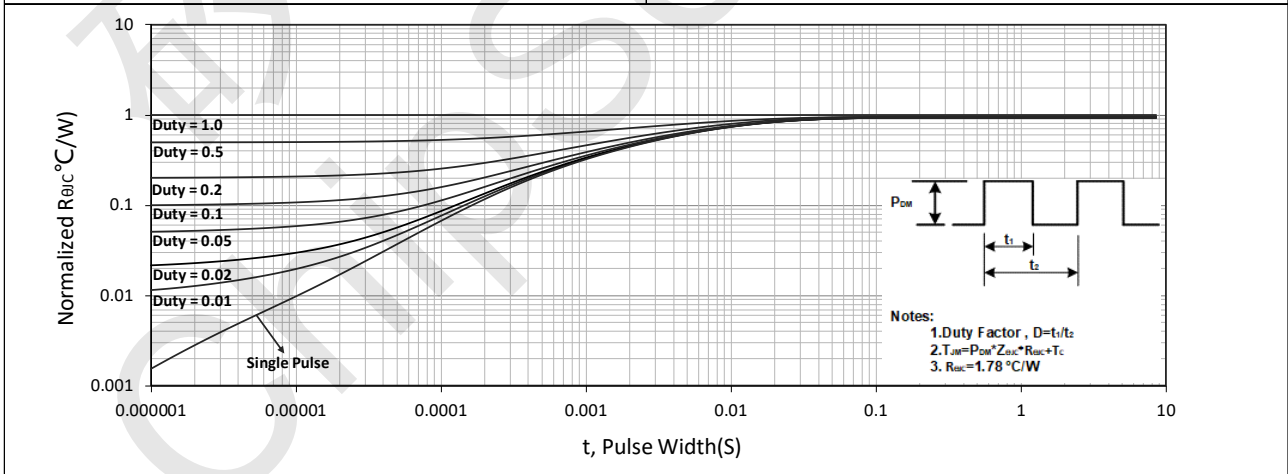
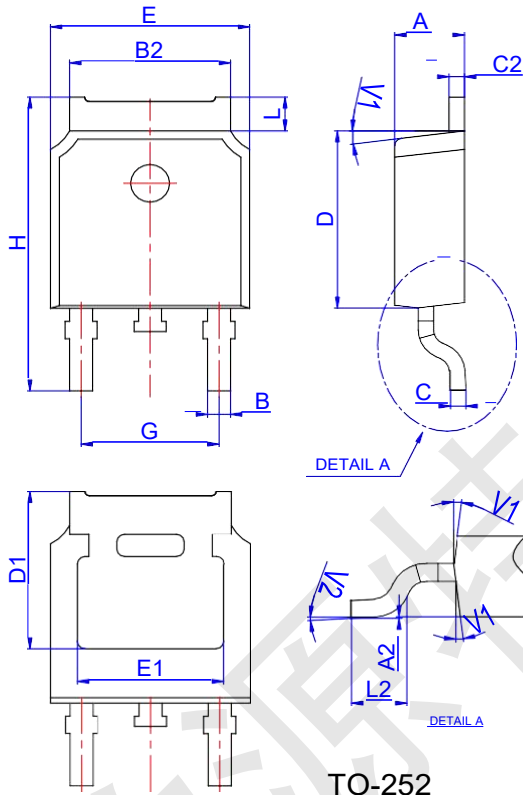

Figure 11. Normalized Maximum Transient Thermal Impedance



CST20P10 Package Mechanical Data-TO-252



Ref.	Dimensions					
	Millimeters			Inches		
	Min.	Typ.	Max.	Min.	Typ.	Max.
A	2.10		2.50	0.083		0.098
A2	0		0.10	0		0.004
B	0.66		0.86	0.026		0.034
B2	5.18		5.48	0.202		0.216
C	0.40		0.60	0.016		0.024
C2	0.44		0.58	0.017		0.023
D	5.90		6.30	0.232		0.248
D1	5.30REF			0.209REF		
E	6.40		6.80	0.252		0.268
E1	4.63			0.182		
G	4.47		4.67	0.176		0.184
H	9.50		10.70	0.374		0.421
L	1.09		1.21	0.043		0.048
L2	1.35		1.65	0.053		0.065
V1		7°			7°	
V2	0°		6°	0°		6°

Reel Spectification-TO-252-4R

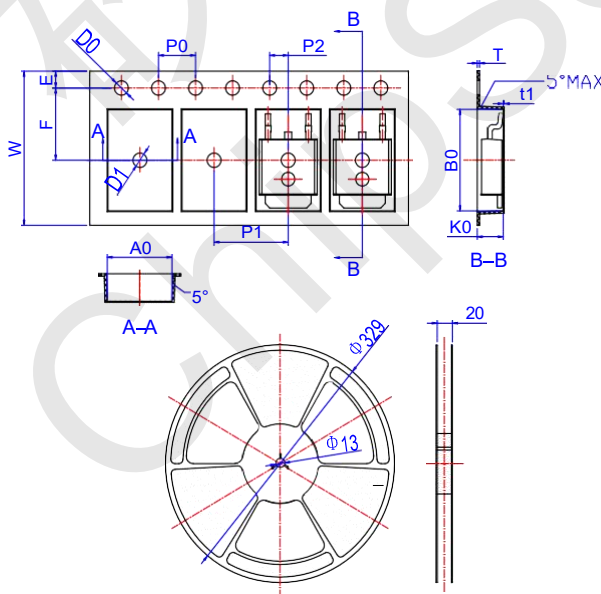

Ref.	Dimensions					
	Millimeters			Inches		
	Min.	Typ.	Max.	Min.	Typ.	Max.
W	15.90	16.00	16.10	0.626	0.630	0.634
E	1.65	1.75	1.85	0.065	0.069	0.073
F	7.40	7.50	7.60	0.291	0.295	0.299
D0	1.40	1.50	1.60	0.055	0.059	0.063
D1	1.40	1.50	1.60	0.055	0.059	0.063
P0	3.90	4.00	4.10	0.154	0.157	0.161
P1	7.90	8.00	8.10	0.311	0.315	0.319
P2	1.90	2.00	2.10	0.075	0.079	0.083
A0	6.85	6.90	7.00	0.270	0.271	0.276
B0	10.45	10.50	10.60	0.411	0.413	0.417
K0	2.68	2.78	2.88	0.105	0.109	0.113
T	0.24		0.27	0.009		0.011
t1	0.10			0.004		
10P0	39.80	40.00	40.20	1.567	1.575	1.583