



AXS2020概要:

AXS2020是一款FM无干扰、带防破音AB/D类可切换、高效率、无滤波器的5.2W单声道音频功率放大器。超低的EMI非常适合应用于带FM功能的便携式设备中。

AXS2020的差分输入架构和极高的PSRR有效地提高了AXS2020对RF噪声的抑制能力。无需滤波器的PWM调制结构及增益内置方式减少了外部元件、PCB面积和系统成本,并简化了设计。高达90%的效率,快速地启动时间和纤小的封装尺寸使得AXS2020成为便携式音频产品的最佳选择。

AXS2020具有极低的关断电流,极大的延长系统的待机时间。OCP、OTP、UVLO保护功能增强系统的可靠性。开启、关闭POP-click抑制功能改善了系统的听觉感受,同时简化系统调试。

AXS2020提供带散热片的ESOP8封装

AXS2020特性:

- AB类、D类切换功能
- 2种防破音可选, 防破音压缩范围-10dB
- D类输出功率:
 - 5.2W (VDD=5.0V, RL =2Ω, THD+N=10%)
 - 3.1W (VDD=5.0V, RL =4Ω, THD+N=10%)
- AB类输出功率:
 - 5.2W (VDD=5.0V, RL =2Ω, THD+N=10%)
 - 3.1W (VDD=5.0V, RL =4Ω, THD+N=10%)
- 工作电压: 2.5V to 5.5V
- 低失真和低噪声
- 开启、关闭POP-click抑制功能
- 关断电流 (<1uA)
- OCP、OTP、UVLO保护功能

AXS2020应用:

- 扩音器
- 便携式音箱 / 插卡音箱
- 蓝牙音箱 / USB音箱

AXS2020典型应用电路图:

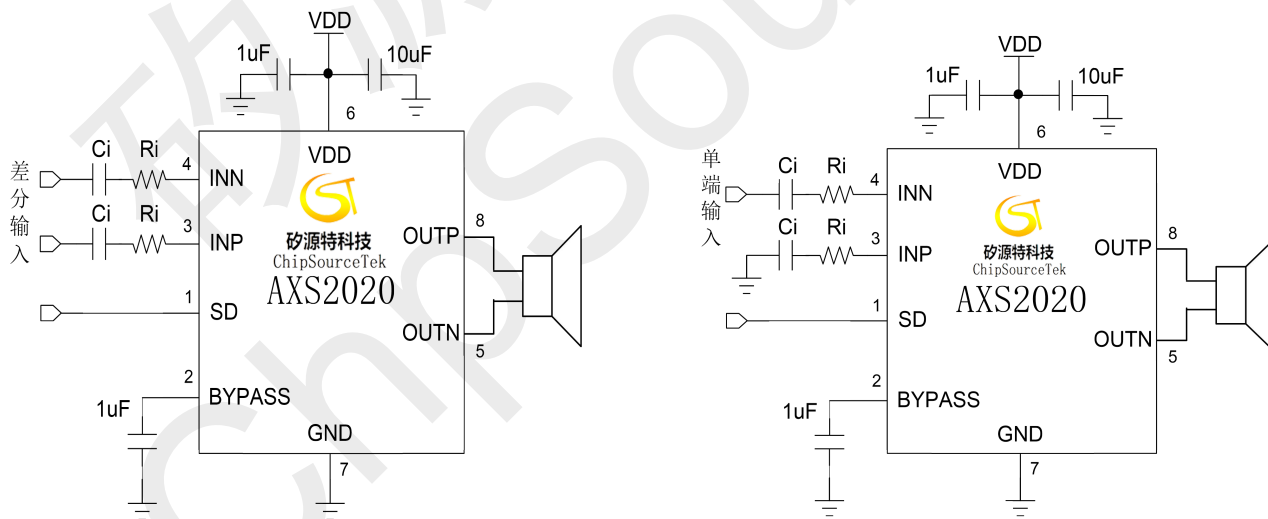

注: 防破音模式切换另有说明, SD 电压大于 2.3V 工作在 D 类防破音模式 1。



AXS2020引脚排列:



管脚描述

管脚	符号	I/O	描述
1	SD	I	系统关断控制 (SD 电压大于 2.3V 工作在 D 类防破音模式 1; SD 电压在 1.7V~2.1V 工作在 D 类防破音关闭; SD 电压在 1.2V~1.5V 工作在 A B 类; SD 电压小于 0.35V, 芯片关断;)
2	BYPASS	I	参考电压
3	INP	I	音频正输入端
4	INN	I	音频负输入端
5	OUTN	O	音频负输出端
6	VDD		电源
7	GND		地
8	OUTP	O	音频正输出端
9(Thermal Pad)	GND		芯片底部散热片接地



AXS2020订货信息:

料号	封装	表面印字	包装
AXS2020	ESOP8	AXS2020 XXXXXXXX XXXX	4000颗/卷

AXS2020绝对最大额定值:

V _{DD}	供电电压	-0.3V to 6.0V
V _I	输入电压	-0.3V to V _{DD} +0.3V
T _A	工作温度	-40°C to 85°C
T _J	结温	-40°C to 125°C
T _{STG}	储存温度	-65°C to 150°C
T _{SLD}	焊接温度	300°C, 5sec

AXS2020推荐的工作条件:

Symbol	Parameter	Test Conditions	MIN	MAX	UNIT
V _{DD}	供电电压	V _{DD}	2.5	5.5	V
V _{IH}	SD高电平(防破音模式1)	V _{DD} =2.5V to 5.0V	2.3	5.5	V
	SD高电平(防破音模式关)		1.7	2.1	V
	SD高电平(AB类模式)		1.2	1.5	V
V _{IL}	SD低电平	V _{DD} =2.5V to 5.0V		0.35	V

AXS2020热效应参数:

Parameter	Symbol	Package	MAX	UNIT
热阻(Junction to Ambient)	θ _{JA}	ESOP8	40	°C/W
热阻(Junction to Case)	θ _{JC}	ESOP8	11	°C/W



AXS2020 CLASS D Mode Electrical Characteristics:

(VDD =5V, Gain=22dB, RL =4Ω, T =25°C, unless otherwise noted.)

Symbol	Parameter	Test Conditions	MIN	TYP	MAX	UNIT
V _{IN}	电源电压		2.5	-	5.5	V
P _O	D 类模式输出功率	THD+N=10%,f=1KHZ,RL=4Ω	V _{DD} =5.0V	3.1		W
			V _{DD} =3.6V	1.7		
		THD+N=1%,f=1KHZ,RL=4Ω	V _{DD} =5.0V	2.8		W
			V _{DD} =3.6V	1.45		
		THD+N=10%,f=1KHZ,RL=2Ω	V _{DD} =5.0V	5.2		W
			V _{DD} =3.6V	2.9		
THD+N=1%,f=1KHZ,RL=2Ω	V _{DD} =5.0V	4.7		W		
	V _{DD} =3.6V	2.4				
THD+N	总谐波失真+噪声	V _{DD} =5.0V, P _O =1W, RL=4Ω	f=1KHz	0.09		%
				V _{DD} =3.6V, P _O =1W, RL=4Ω	0.1	
		V _{DD} =5.0V, P _O =2W, RL=2Ω	f=1KHz	0.1		%
				V _{DD} =3.6V, P _O =2W, RL=2Ω	0.2	
G _v	D 类模式增益	R _i = 22K		23		dB
PSRR	电源纹波抑制比	V _{DD} =4.2V ±200mVp-p	f=1KHz	60		dB
SNR	信噪比	V _{DD} =5.0V, V _{o rms} =1V, G _v =22dB	f=1KHz	-82		dB
V _n	残余噪声	V _{DD} =5.0V, Input floating with C _{IN} =0.1μF	A-weighting	87		μV
			No	107		
			A-weighting			
Dyn	动态范围	V _{DD} =5.0V, THD=1%	f=1KHz	-88		dB
η	效率	RL=2Ω, P _O =4W	f=1KHz	85		%
		RL=4Ω, P _O =2.8W		90		
I _Q	静态电流	V _{DD} =5.0V	No Load	5		mA
		V _{DD} =3.0V		3		
I _{SD}	关断电流	V _{DD} =2.5V to 5V	V _{SD} =0.3V		1	μA
V _{OS}	失调电压	V _{IN} =0V, V _{DD} =5V		10	40	mV
F _{osc}	工作频率			600		khz
T _{st}	启动时间	Bypass capacitor =1uF		180		mS
OTP	—	No Load, Junction Temperature	V _{DD} =5.0V	165		°C
OTH	—			40		



AXS2020 CLASS AB Mode Electrical Characteristics:

(VDD =5V, Gain=22dB, RL =4Ω, T =25°C, unless otherwise noted.)

Symbol	Parameter	Test Conditions	MIN	TYP	MAX	UNIT
Po	F 类模式输出功率	THD+N=10%,f=1KHZ,RL=4Ω	VDD=5.0V	3.1		W
			VDD=3.6V	1.7		
		THD+N=1%,f=1KHZ,RL=4Ω	VDD=5.0V	2.6		W
			VDD=3.6V	1.25		
		THD+N=10%,f=1KHZ,RL=2Ω	VDD=5.0V	5.2		W
			VDD=3.6V	2.85		
THD+N=1%,f=1KHZ,RL=2Ω	VDD=5.0V	4.7		W		
	VDD=3.6V	2.25				
THD+N	总谐波失真+噪声	VDD=5.0V, Po=1W, RL=4Ω	f=1KHz	0.06		%
				VDD=3.6V, Po=1W, RL=4Ω	0.12	
		VDD=5.0V, Po=2W, RL=2Ω	f=1KHz	0.1		%
				VDD=3.6V, Po=2W, RL=2Ω	0.26	
Gv	AB 类模式增益	Ri = 22K		23		dB
PSRR	电源纹波抑制比	VDD=4.2V ±200mVp-p	f=1KHz	62		dB
SNR	信噪比	VDD=5.0V, Vorms=1V, GV=22dB	f=1KHz	-82		dB
Vn	残余噪声	VDD=5.0V, Input floating with CIN=0.1μF	A-weighting	81		μV
			No A-weighting	103		
Dyn	动态范围	VDD=5.0V, THD=1%	f=1KHz	-85		dB
Iq	静态电流	VDD=5.0V	No Load	10		mA
		VDD=3.0V		7		
IsD	关断电流	VIN=0V, VDD=5V			1	μA
Vos	失调电压	VIN=0V, VDD=5V		10	40	mV
Tst	启动时间	Bypass capacitor =1uF		180		mS
OTP	—	No Load, Junction	VDD=5.0V	165		°C
OTH	—	Temperature		40		



AXS2020典型特征曲线 (D类工作模式):

(VDD =5V, Gain=22dB, $R_L =4\Omega$, T =25°C, unless otherwise noted.)

THD+N vs Output Power

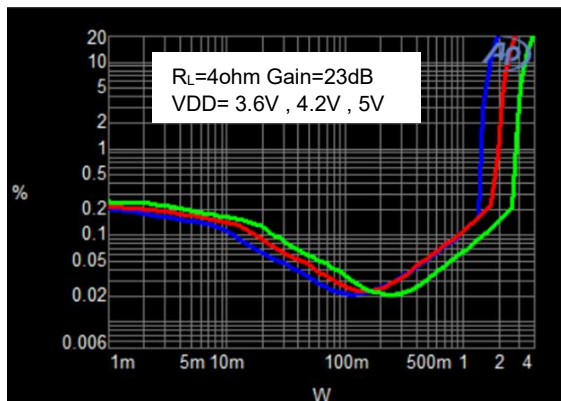

THD+N vs Output Power

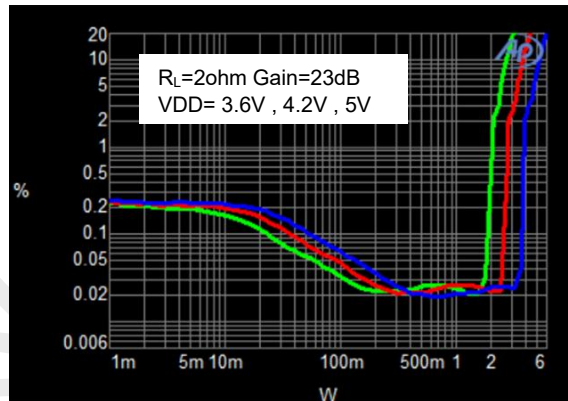

THD+N VS FREQUENCY

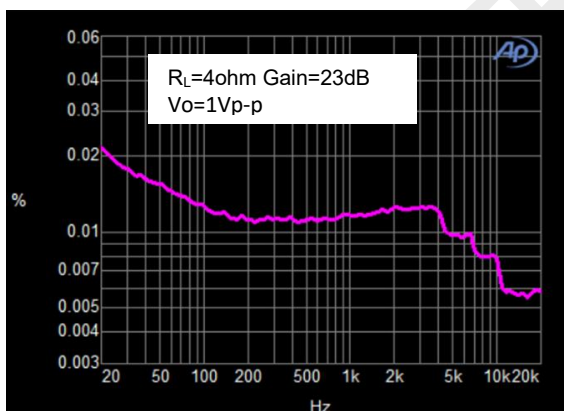

Frequency Response

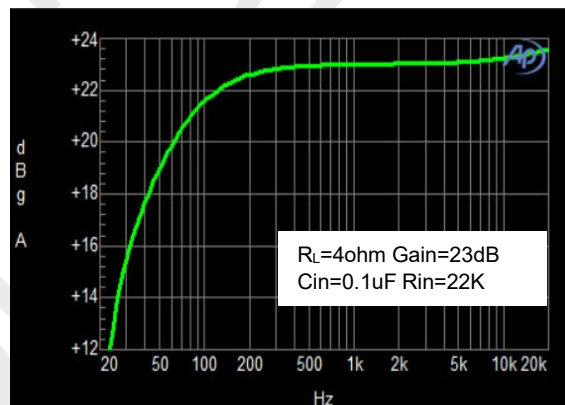

THD+N VS FREQUENCY

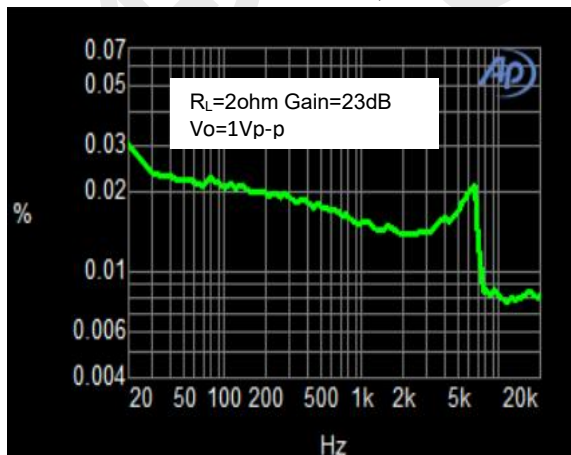

NOISE FLOOR FFT

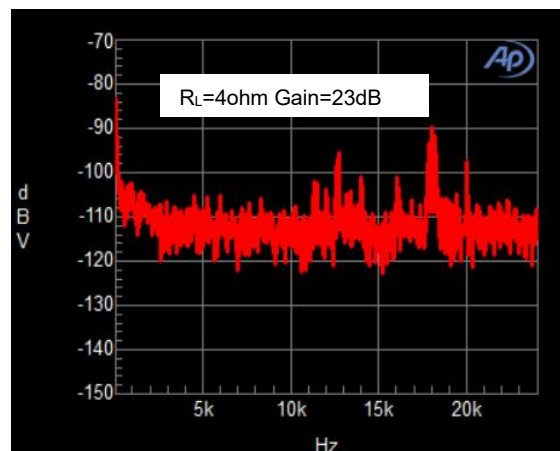



AXS2020典型特征曲线 (AB类工作模式) :

(VDD =5V, Gain=23dB, $R_L =4\Omega$, T =25°C, unless otherwise noted.)

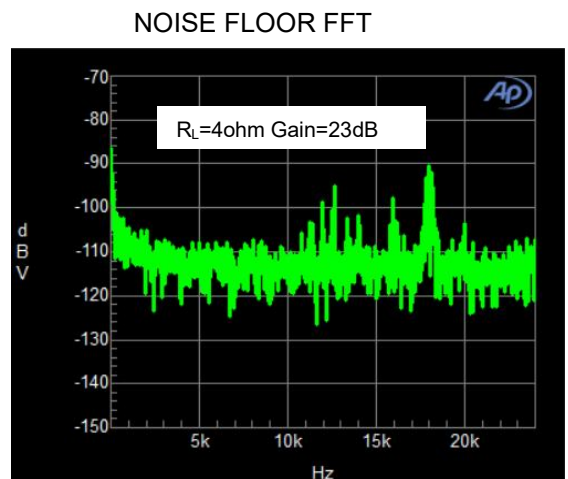
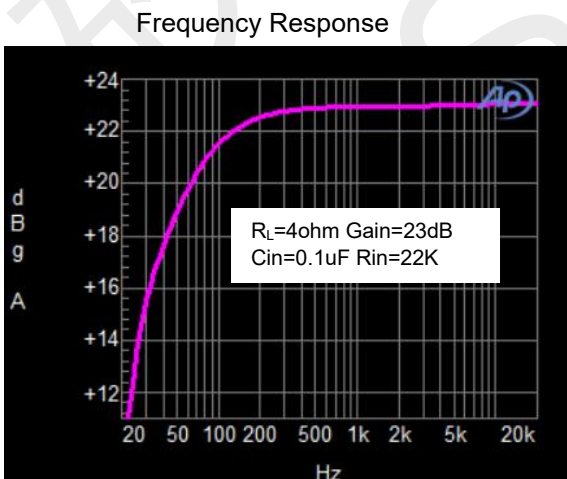
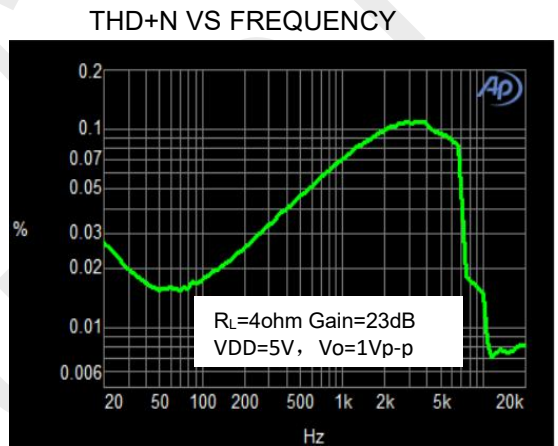
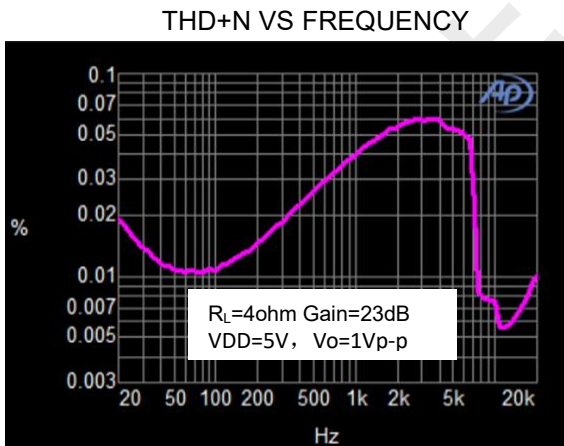
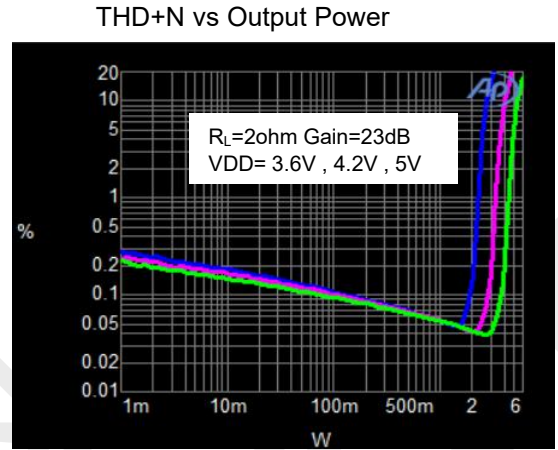
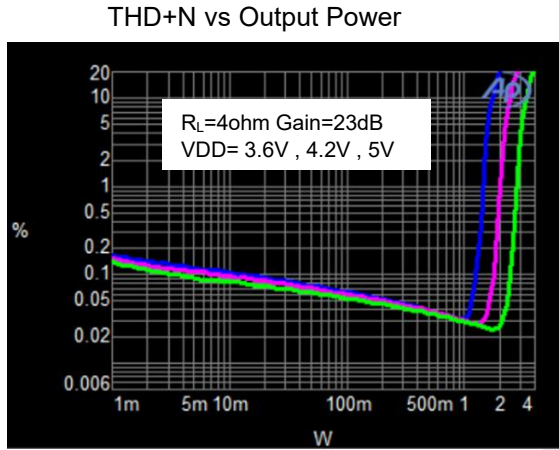



AXS2020应用信息:

输入电阻(Ri)

AXS2020的增益由音量调节控制的输入电阻(RI)和反馈电阻RF)控制。增益计算公式:

$$A_v = \frac{R_f}{R_i + 5} \left(\frac{V}{V} \right)$$

其中, 输入电阻RI为外部的输入电阻 (AXS2020内部集成输入电阻为5KΩ), 反馈电阻Rf为400KΩ (反馈电阻为内部固定, 不可外部调节)。例如, 外部输入电阻为22K, 则放大倍数为:

$$A_v = 400 / (22+5) = 14.8 \text{ 倍} = 23.4 \text{ dB}$$

输入电容 (Ci)

输入电容与输入电阻构成一个高通滤波器, 其截止频率可由下式得出:

$$f_c = \frac{1}{(2\pi R_i C_i)}$$

Ci的值不仅会影响到电路的低频响应, 而且也会影响电路启动和关断时所产生的POP声, 输入电容越大, 则到达其稳定工作点所需的电荷越多, 在同等条件下, 小的输入电容所产生的POP声比较小。

偏置电容CBYP

偏置电容是最关键的电容, 它与几个重要性能相关, 当电路启动时, 偏置电容决定了放大器的开启速度, 偏置电容同时会影响到电路的噪声, 电源抑制比以及开关机的POP声。

为避免启动时的POP声, 偏置电压的上升速度应该比输入偏置电压的上升速度慢。

SD管脚控制

为了减少在关断模式下的功率损耗, AXS2020带有关闭放大器偏置的关断电路。当SD管脚电压小于0.35V, 芯片关断, 工作电流达到最小。当SD管脚电压在1.7V~2.1V则AXS2020进入D类防破音关闭的模式。当SD电压在1.2V~1.5V工作在AB类。当SD管脚直接拉高且电压大于2.3V, AXS2020默认进入到D类防破音模式1。

过温保护

AXS2020 有过温保护电路以防止内部温度超过165°C时器件损坏。在不同器件之间, 这个值有25°C的差异。当内部电路超过设置的保护温度时, 器件进入关断状态, 输出被截止。当温度下降 40°C后, 器件重新正常工作。



AXS2020封装图 (ESOP8)

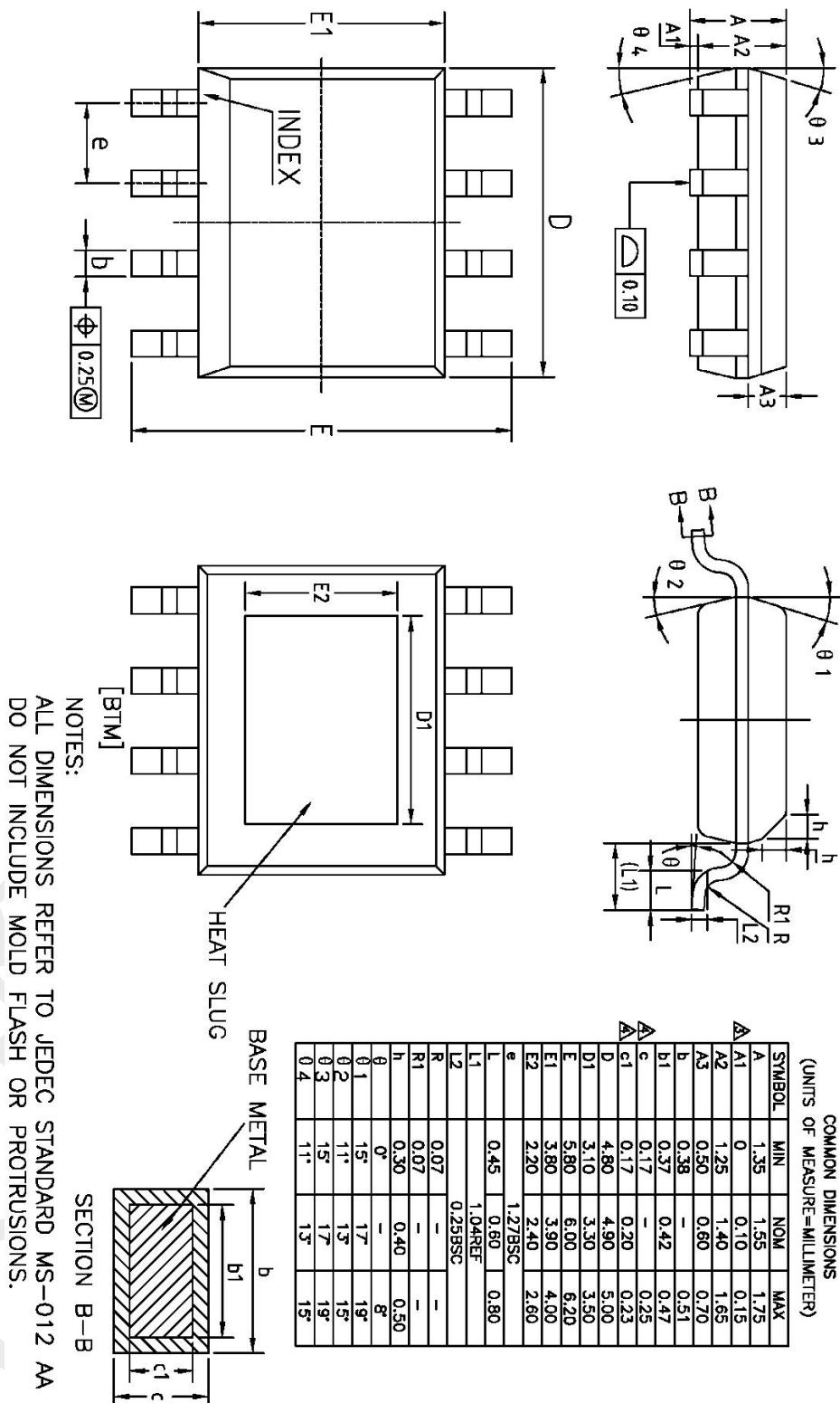

声明:

深圳市矽源特科技有限公司不对本公司产品以外的任何电路使用负责, 也不提供其专利许可。
深圳市矽源特科技有限公司保留在任何时间、没有任何通报的前提下修改产品资料和规格的权利。